

Set-2

Series A2DDC/2

प्रश्न-पत्र कोड  
Q.P. Code

31/2/2

रोल नं.   
Roll No.



परीक्षार्थी प्रश्न-पत्र कोड को उत्तर-पुस्तिका के मुख-पृष्ठ पर अवश्य लिखें।

Candidates must write the Q.P. Code on the title page of the answer-book.

## विज्ञान SCIENCE

निर्धारित समय : 3 घण्टे

Time allowed : 3 hours

अधिकतम अंक : 80

Maximum Marks : 80

नोट	NOTE
(I) कृपया जाँच कर लें कि इस प्रश्न-पत्र में मुद्रित पृष्ठ 23 हैं।	(I) Please check that this question paper contains <b>23</b> printed pages.
(II) कृपया जाँच कर लें कि इस प्रश्न-पत्र में 39 प्रश्न हैं।	(II) Please check that this question paper contains <b>39</b> questions.
(III) प्रश्न-पत्र में दाहिने हाथ की ओर दिए गए प्रश्न-पत्र कोड को परीक्षार्थी उत्तर-पुस्तिका के मुख-पृष्ठ पर लिखें।	(III) Q.P. Code given on the right hand side of the question paper should be written on the title page of the answer-book by the candidate.
(IV) कृपया प्रश्न का उत्तर लिखना शुरू करने से पहले, उत्तर-पुस्तिका में प्रश्न का क्रमांक अवश्य लिखें।	(IV) Please write down the serial number of the question in the answer-book before attempting it.
(V) इस प्रश्न-पत्र को पढ़ने के लिए 15 मिनट का समय दिया गया है। प्रश्न-पत्र का वितरण पूर्वाह्न में 10.15 बजे किया जाएगा। 10.15 बजे से 10.30 बजे तक परीक्षार्थी केवल प्रश्न-पत्र को पढ़ेंगे और इस अवधि के दौरान वे उत्तर-पुस्तिका पर कोई उत्तर नहीं लिखेंगे।	(V) 15 minute time has been allotted to read this question paper. The question paper will be distributed at 10.15 a.m. From 10.15 a.m. to 10.30 a.m., the candidates will read the question paper only and will not write any answer on the answer-book during this period.

2131/2/2

111 B

1

P.T.O.

सामान्य निर्देश :

निम्नलिखित निर्देशों को सावधानी से पढ़िए और उनका सख्ती से पालन कीजिए :

- (i) इस प्रश्न-पत्र में कुल 39 प्रश्न हैं। सभी प्रश्न अनिवार्य हैं।
- (ii) यह प्रश्न-पत्र पाँच खण्डों में विभाजित किया गया है – खण्ड-क, ख, ग, घ तथा ङ।
- (iii) खण्ड-क में प्रश्न संख्या 1 से 20 तक बहुविकल्पीय प्रकार के प्रश्न हैं। प्रत्येक प्रश्न 1 अंक का है।
- (iv) खण्ड-ख में प्रश्न संख्या 21 से 26 तक अति लघु-उत्तरीय प्रकार के प्रश्न हैं। प्रत्येक प्रश्न 2 अंकों का है। इन प्रश्नों के उत्तर 30 से 50 शब्दों में दिए जाने चाहिए।
- (v) खण्ड-ग में प्रश्न संख्या 27 से 33 तक लघु-उत्तरीय प्रकार के प्रश्न हैं। प्रत्येक प्रश्न 3 अंकों का है। इन प्रश्नों के उत्तर 50 से 80 शब्दों में दिए जाने चाहिए।
- (vi) खण्ड-घ में प्रश्न संख्या 34 से 36 तक दीर्घ उत्तरीय प्रकार के प्रश्न हैं। प्रत्येक प्रश्न 5 अंकों का है। इन प्रश्नों के उत्तर 80 से 120 शब्दों में दिए जाने चाहिए।
- (vii) खण्ड-ङ में प्रश्न संख्या 37 से 39 तक 3 स्रोत-आधारित/प्रकरण-आधारित इकाइयों के मूल्यांकन के 4 अंकों के प्रश्न (उपप्रश्नों सहित) हैं।
- (viii) प्रश्न-पत्र में समग्र विकल्प नहीं दिया गया है। यद्यपि, कुछ खण्डों में आंतरिक विकल्प दिए गए हैं। इस प्रकार के प्रश्नों में केवल एक ही विकल्प का उत्तर दीजिए।



## General Instructions :

**Read the following instructions very carefully and strictly follow them :**

- (i) *This question paper comprises **39** questions. **All** questions are compulsory.*
- (ii) *This question paper is divided into **FIVE** sections viz. Section **A, B, C, D** and **E**.*
- (iii) *In Section **A** - question number **1** to **20** are Multiple Choice Questions (MCQs) carrying **1** mark each.*
- (iv) *In Section **B** - question number **21** to **26** are Very Short Answer (VSA) type questions carrying **2** marks each. Answer to these questions should be in the range of **30** to **50** words.*
- (v) *In Section **C** - question number **27** to **33** are Short Answer (SA) type questions carrying **3** marks each. Answer to these questions should be in the range of **50** to **80** words.*
- (vi) *In Section **D** - question number **34** to **36** are Long Answer (LA) type questions carrying **5** marks each. Answer to these questions should be in the range of **80** to **120** words.*
- (vii) *In Section **E** - question number **37** to **39** are of **3** source-based/case-based units of assessment carrying **4** marks each with sub-parts.*
- (viii) *There is no overall choice. However, an internal choice has been provided in some Sections. Only one of the alternatives has to be attempted in such questions.*



प्रश्न 1 से 20 तक के प्रश्नों में दिए गए चार विकल्पों में से सबसे उचित एक विकल्प चुनिए और लिखिए।

1. कार्बन यौगिकों की समजातीय श्रेणी के बारे में नीचे दिए गए कथनों पर विचार कीजिए : 1
  - (a) सभी उत्तरोत्तर (क्रमागत) सदस्यों के बीच – CH<sub>2</sub> इकाई का अन्तर होता है।
  - (b) आण्विक द्रव्यमान में वृद्धि होने पर गलनांक और क्वथनांक में वृद्धि होती है।
  - (c) दो क्रमागत सदस्यों के आण्विक द्रव्यमानों के बीच 16 u का अन्तर होता है।
  - (d) C<sub>2</sub>H<sub>2</sub> और C<sub>3</sub>H<sub>4</sub> एल्काइन श्रेणी के क्रमागत सदस्य नहीं हैं।

इनमें सही कथन हैं –

(A) (a) और (b)	(B) (b) और (c)
(C) (a) और (c)	(D) (c) और (d)
  
2. पोटैशियम (परमाणु संख्या 19) का इलेक्ट्रॉन विन्यास लिखने के लिए कितने कोशों की आवश्यकता होती है ? 1

(A) 1	(B) 2
(C) 3	(D) 4
  
3. निम्नलिखित में से उस प्रक्रिया को चुनिए जिसमें संयोजन अभिक्रिया होती है : 1

(A) श्वेत-श्याम फोटोग्राफी	(B) कोयले का जलना (दहन)
(C) मेथेन का दहन	(D) भोजन का पाचन
  
4. वह कौन सा ऑक्साइड है जो HCl से अभिक्रिया करने के साथ-साथ KOH से भी अभिक्रिया करके तदनरूप लवण और जल बनाता है ? 1

(A) CuO	(B) Al <sub>2</sub> O <sub>3</sub>
(C) Na <sub>2</sub> O	(D) K <sub>2</sub> O
  
5. निम्नलिखित में से कौन कॉपर और टिन का मिश्रातु है ? 1

(A) निक्रोम	(B) पीतल
(C) कान्सटेन्टन	(D) ब्राँज



SECTION – A

(20 × 1 = 20)

Select and write one most appropriate option out of the four options given for each of the questions 1 to 20 :

1. Consider the following statements about homologous series of carbon compounds : 1
- (a) All succeeding members differ by – CH<sub>2</sub> unit.
  - (b) Melting point and boiling point increases with increasing molecular mass.
  - (c) The difference in molecular masses between two successive members is 16 u.
  - (d) C<sub>2</sub>H<sub>2</sub> and C<sub>3</sub>H<sub>4</sub> are **NOT** the successive members of alkyne series.
- The correct statements are –
- (A) (a) and (b) (B) (b) and (c)
  - (C) (a) and (c) (D) (c) and (d)
2. The number of shells required to write the electronic configuration of Potassium (At. No. 19) 1
- (A) 1 (B) 2
  - (C) 3 (D) 4
3. Select from the following a process in which a combination reaction is involved : 1
- (A) Black and White photography (B) Burning of coal
  - (C) Burning of methane (D) Digestion of food
4. The oxide which can react with HCl as well as KOH to give corresponding salt and water is 1
- (A) CuO (B) Al<sub>2</sub>O<sub>3</sub>
  - (C) Na<sub>2</sub>O (D) K<sub>2</sub>O
5. Which of the following is an alloy of copper and tin ? 1
- (A) Nichrome (B) Brass
  - (C) Constantan (D) Bronze

2131/2/2

5

P.T.O.



6. pH के किस मान पर दन्त क्षय होने लगता है ? 1
- (A) 5.1 (B) 5.8  
(C) 6.5 (D) 8.0
7. ठोस कैल्सियम ऑक्साइड जल से तीक्ष्ण अभिक्रिया करके कैल्सियम हाइड्रॉक्साइड बनाता है तथा ऊष्मा का मोचन होता है। उपरोक्त सूचना से यह निष्कर्ष निकाला जा सकता है कि यह अभिक्रिया 1
- (A) ऊष्माशोषी है तथा बनने वाले विलयन का pH 7 से अधिक है।  
(B) ऊष्माक्षेपी है तथा बनने वाले विलयन का pH 7 है।  
(C) ऊष्माशोषी है तथा बनने वाले विलयन का pH 7 है।  
(D) ऊष्माक्षेपी है तथा बनने वाले विलयन का pH 7 से अधिक है।
8. मानव श्वसन तंत्र में जब कोई व्यक्ति श्वास अन्दर लेता है तो पसलियों की स्थिति और डायाफ्राम की स्थितियाँ क्या होती हैं ? 1
- (A) पसलियाँ ऊपर उठी हुई तथा डायाफ्राम सक्रीय/उभार लिए होता है।  
(B) पसलियाँ ऊपर उठी हुई तथा डायाफ्राम चपटा होता है।  
(C) पसलियाँ शिथिल तथा डायाफ्राम चपटा होता है।  
(D) पसलियाँ शिथिल तथा डायाफ्राम सक्रीय/उभार लिए होता है।
9. निम्नलिखित में से उस ग्रंथि को चुनिए जो मानव शरीर में जोड़ों में नहीं पायी जाती है : 1
- (A) पीयूष (B) अण्डाशय  
(C) वृषण (D) अधिवृक्क
10. मानव हृदय के विषय में निम्न में से कौन सा/से कथन सही है/हैं ? 1
- (a) दायाँ अलिन्द फुफ्फुस से फुफ्फुसीय धमनियों द्वारा ऑक्सीजनित रुधिर प्राप्त करता है।  
(b) बायाँ अलिन्द बाएँ निलय को ऑक्सीजनित रुधिर स्थानान्तरित करता है जो इसे शरीर के विभिन्न भागों को भेज देता है।  
(c) दायाँ अलिन्द ऊपरी और निचले शरीर से महाशिरा द्वारा अनॉक्सीजनित रुधिर प्राप्त करता है।  
(d) बायाँ अलिन्द महाधमनी को ऑक्सीजनित रुधिर स्थानान्तरित करता है जो इसे शरीर के विभिन्न भागों को भेज देता है।
- (A) (a) (B) (a) और (d)  
(C) (b) और (c) (D) (b) और (d)



6. Tooth decay begins at the pH of : 1  
(A) 5.1 (B) 5.8  
(C) 6.5 (D) 8.0
7. Solid Calcium oxide reacts vigorously with water to form Calcium hydroxide accompanied by the liberation of heat. From the information given above it may be concluded that this reaction 1  
(A) is endothermic and pH of the solution formed is more than 7.  
(B) is exothermic and pH of the solution formed is 7.  
(C) is endothermic and pH of the solution formed is 7.  
(D) is exothermic and pH of the solution formed is more than 7.
8. In human respiratory system, when a person breathes in, the position of ribs and diaphragm will be : 1  
(A) lifted ribs and curve/dome shaped diaphragm.  
(B) lifted ribs and flattened diaphragm.  
(C) relaxed ribs and flattened diaphragm.  
(D) relaxed ribs and curve/dome shaped diaphragm.
9. Select out of the following a gland which does **NOT** occur as a pair in the human body : 1  
(A) Pituitary (B) Ovary  
(C) Testis (D) Adrenal
10. Which of the following statement(s) is (are) true about human heart ? 1  
(a) Right atrium receives oxygenated blood from lungs through pulmonary artery.  
(b) Left atrium transfers oxygenated blood to left ventricle which sends it to various parts of the body.  
(c) Right atrium receives deoxygenated blood through vena cava from upper and lower body.  
(d) Left atrium transfers oxygenated blood to aorta which sends it to different parts of the body.  
(A) (a) (B) (a) and (d)  
(C) (b) and (c) (D) (b) and (d)



11. नीचे दिए गए आरेख में किस जीव को निरूपित किया गया है ?

1

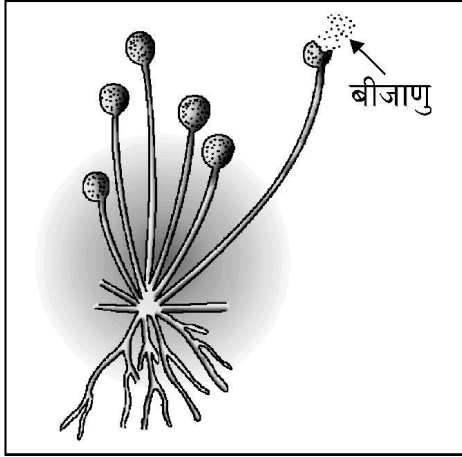

(A) स्पाइरोगायरा

(B) प्लैनेरिया

(C) यीस्ट

(D) राइज़ोपस

12. दो मटर के पौधों के बीच संकरण कराने पर 50% लम्बे पौधे तथा 50% बौने पौधे प्राप्त हुए। जनक पौधों का जीन संयोजन क्या था ?

1

(A) Tt और Tt

(B) TT और Tt

(C) Tt और tt

(D) TT और tt

13. किसी धारावाही परिनालिका द्वारा उत्पन्न चुम्बकीय क्षेत्र की तीव्रता निम्नलिखित में से किस पर निर्भर नहीं करती है ?

1

(A) परिनालिका में फेरों की संख्या

(B) परिनालिका से प्रवाहित धारा की दिशा

(C) परिनालिका की त्रिज्या

(D) परिनालिका के क्रोड का पदार्थ

14. विद्युत प्रतिरोधकता का S.I. मात्रक है –

1

(A) ओम प्रति मीटर<sup>3</sup>

(B) ओम प्रति मीटर<sup>2</sup>

(C) ओम . मीटर

(D) ओम . मीटर<sup>3</sup>

15. पाँच प्रतिरोधकों जिनमें प्रत्येक का प्रतिरोध  $10 \Omega$  है के उपयोग से निम्नतम कितना प्रतिरोध बनाया जा सकता है ?

1

(A)  $\frac{1}{50} \Omega$

(B)  $\frac{1}{5} \Omega$

(C)  $2 \Omega$

(D)  $1 \Omega$

2131/2/2

8



11. Which one of the following organism is represented by this diagram ? 1

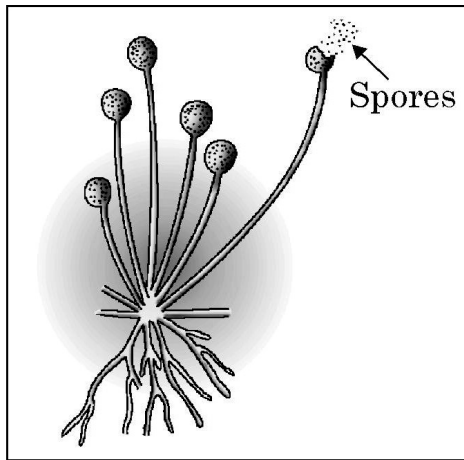

- (A) Spirogyra (B) Planaria  
(C) Yeast (D) Rhizopus

12. A cross made between two pea plants produces 50% tall and 50% short pea plants. The gene combination of the parental pea plants must be 1

- (A) Tt and Tt (B) TT and Tt  
(C) Tt and tt (D) TT and tt

13. Strength of magnetic field produced by a current carrying solenoid **DOES NOT** depend upon : 1

- (A) number of turns in the solenoid  
(B) direction of the current flowing through it  
(C) radius of solenoid  
(D) material of core of the solenoid

14. S.I. unit of electrical resistivity is 1

- (A) ohm per metre<sup>3</sup> (B) ohm per metre<sup>2</sup>  
(C) ohm . metre (D) ohm . metre<sup>3</sup>

15. The minimum resistance which can be made using five resistors each of resistance 10 Ω is : 1

- (A)  $\frac{1}{50} \Omega$  (B)  $\frac{1}{5} \Omega$   
(C) 2 Ω (D) 1 Ω



16. मानव नेत्र के संदर्भ में नीचे दिए गए कथनों पर विचार कीजिए :

1

- (a) नेत्र गोलक का व्यास लगभग 2.3 cm होता है ।
- (b) परितारिका गहरा पेशीय डायफ्राम होता है जो पुतली के साइज़ को नियंत्रित करता है ।
- (c) नेत्र में प्रवेश करने वाली प्रकाश किरणों का अधिकांश अपवर्तन क्रिस्टलीय लेंस पर होता है ।
- (d) विभिन्न दूरियों के बिम्बों को फोकसित करते समय रेटिना और क्रिस्टलीय लेंस के बीच की दूरी पक्ष्माभी पेशियों द्वारा समायोजित की जाती है ।

इनमें सही कथन हैं –

- (A) (a) और (b) (B) (a), (b) और (c)
- (C) (b), (c) और (d) (D) (a), (c) और (d)

**प्रश्न संख्या 17 से 20 अभिकथन – कारण पर आधारित प्रश्न हैं :**

इन प्रश्नों में दो कथन – अभिकथन (A) और कारण (R) दिए गए हैं । इन प्रश्नों के उत्तर नीचे दिए अनुसार उचित विकल्प को चुनकर दीजिए :

- (A) (A) और (R) दोनों सही हैं तथा (R) द्वारा (A) की सही व्याख्या हो रही है ।
- (B) (A) और (R) दोनों सही हैं, परन्तु (R) द्वारा (A) की सही व्याख्या नहीं हो रही है ।
- (C) (A) सही है, परन्तु (R) गलत है ।
- (D) (A) गलत है, परन्तु (R) सही है ।

17. **अभिकथन (A) :** जब किसी धारावाही तार से प्रवाहित धारा के परिमाण में वृद्धि होती है तो उसके निकट रखी चुम्बकीय सूई के विक्षेपण में कमी हो जाती है ।

1

**कारण (R) :** किसी धारावाही चालक के निकट स्थित किसी बिन्दु पर चुम्बकीय क्षेत्र की तीव्रता धारा में वृद्धि के साथ बढ़ती है ।

18. **अभिकथन (A) :** मानव मादा में लिंग गुणसूत्रों का परिपूर्ण जोड़ा होता है ।

1

**कारण (R) :** युग्मनज में मानव नर के लिंग-गुणसूत्र का योगदान शिशु के लिंग का निर्धारण करता है ।

19. **अभिकथन (A) :** निकट-दृष्टि दोष युक्त नेत्र दूरस्थ बिम्बों को स्पष्ट नहीं देख सकता है ।

1

**कारण (R) :** नेत्र चिकित्सक निकट-दृष्टि दोष के संशोधन के लिए उपयुक्त क्षमता के अभिसारी लेंस का निर्धारण करते हैं ।

20. **अभिकथन (A) :** सक्रियता श्रेणी के मध्य की धातुएँ प्रकृति में सल्फाइडों अथवा कार्बोनेटों के रूप में पायी जाती हैं ।

1

**कारण (R) :** अयस्कों से धातुओं को निष्कर्षित करने के लिए सल्फाइड अयस्कों का निस्तापन तथा कार्बोनेट अयस्कों का भर्जन किया जाता है ।



16. Consider the following statements in the context of human eye : 1
- (a) The diameter of the eye ball is about 2.3 cm.
  - (b) Iris is a dark muscular diaphragm that controls the size of the pupil.
  - (c) Most of the refraction for the light rays entering the eye occurs at the crystalline lens.
  - (d) While focusing on the objects at different distances the distance between the crystalline lens and the retina is adjusted by ciliary muscles.

The correct statements are –

- (A) (a) and (b) (B) (a), (b) and (c)
- (C) (b), (c) and (d) (D) (a), (c) and (d)

**Q. Nos. 17 to 20 are Assertion – Reason based questions :**

These questions consist of two statements – Assertion (A) and Reason (R). Answer these questions selecting the appropriate option given below :

- (A) Both (A) and (R) are true and (R) is the correct explanation of (A).
- (B) Both (A) and (R) are true, but (R) is not the correct explanation of (A).
- (C) (A) is true, but (R) is false.
- (D) (A) is false, but (R) is true.

17. **Assertion (A) :** The deflection of a compass needle placed near a current carrying wire decreases when the magnitude of an electric current in the wire is increased. 1

**Reason (R) :** Strength of the magnetic field at a point due to a current carrying conductor increases on increasing the current in the conductor.

18. **Assertion (A) :** Human female has a perfect pair of sex chromosome. 1  
**Reason (R) :** Sex chromosome contributed by the human male in the zygote decides the sex of a child.

19. **Assertion (A) :** Myopic eye cannot see distant objects distinctly. 1  
**Reason (R) :** For the correction of myopia converging lenses of appropriate power are prescribed by eye-surgeons.

20. **Assertion (A) :** Metals in the middle of activity series are found in nature as sulphides or carbonates. 1  
**Reason (R) :** The sulphide ores are calcinated whereas carbonate ores are roasted to extract metals from them.



### खण्ड – ख

प्रश्न संख्या 21 से 26 अति लघु उत्तरीय प्रश्न हैं ।

21. (a) अपघटन (वियोजन) अभिक्रिया की परिभाषा लिखिए । फेरस सल्फेट के क्रिस्टलों के तापीय अपघटन को दर्शाने के लिए रासायनिक समीकरण लिखिए ।

2

अथवा

- (b) संतुलित रासायनिक समीकरण से क्या तात्पर्य है ? किसी समीकरण को संतुलित करना क्यों आवश्यक है ?

2

22. दो परखनलियों A और B, प्रत्येक में 1 mL स्टार्च विलयन लिया गया । केवल परखनली A में 1 mL लार मिलायी गयी और दोनों परखनलियों को कुछ मिनटों के लिए बिना हिलाए-डुलाए ऐसे ही छोड़ दिया गया । फिर दोनों परखनलियों में तनु आयोडीन विलयन की कुछ बूंदें डाली गयीं ।

2

- (a) इनमें से किस परखनली के विलयन के रंग में परिवर्तन देखा गया ? परिवर्तित रंग का नाम लिखिए ।

- (b) इस कार्यकलाप से क्या निष्कर्ष निकाला जा सकता है ?

23. मानवों में उपस्थित दो प्रकार की जनन कोशिकाओं के नाम लिखिए । इन दोनों के बीच दो संरचनात्मक अन्तरों की सूची बनाइए ।

2

24. (a) प्रकाश के अपवर्तन के दो नियम लिखिए ।

2

अथवा

- (b) किसी माध्यम के निरपेक्ष अपवर्तनांक की परिभाषा लिखिए । कोई प्रकाश किरण निर्वात से अपवर्तनांक 1.5 के काँच में प्रवेश करती है । काँच में प्रकाश की चाल ज्ञात कीजिए । निर्वात में प्रकाश की चाल  $3 \times 10^8$  m/s है ।

2

25. ओम के नियम का उपयोग करके जब नीचे दिए गए आरेख के विद्युत परिपथ में कुंजी बन्द है, तब  $3 \Omega$  प्रतिरोधक के सिरों पर विभवान्तर निर्धारित कीजिए :

2

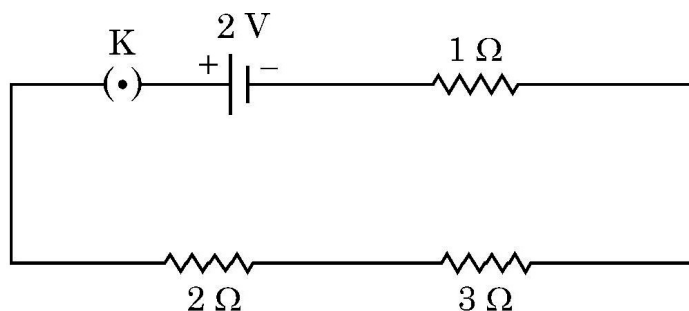

## SECTION – B

**Q. Nos. 21 to 26 are very short answer questions.**

21. (a) Define a decomposition reaction. Write an equation to show thermal decomposition of ferrous sulphate crystals. 2

**OR**

- (b) What is meant by a balanced chemical equation ? Why is it necessary for the equation to be balanced ? 2

22. Two test tubes A and B are taken, each containing one mL of starch solution. Add 1 mL of saliva to test tube 'A' only and leave both the test tubes undisturbed for a few minutes. Now add a few drops of dilute iodine solution to both the test tubes. 2

- (a) Which one of the two test tubes shows change in colour ? Write the changed colour observed in this test tube.  
(b) What can we conclude from this activity ?

23. Name two types of germ cells present in human beings. List two structural differences between the two. 2

24. (a) State two laws of refraction of light. 2

**OR**

- (b) Define the term absolute refractive index of a medium. A ray of light enters from vacuum to glass of absolute refractive index 1.5. Find the speed of light in glass. The speed of light in vacuum is  $3 \times 10^8$  m/s. 2

25. Use Ohm's law to determine the potential difference across the  $3 \Omega$  resistor in the circuit shown in the following diagram when key is closed : 2

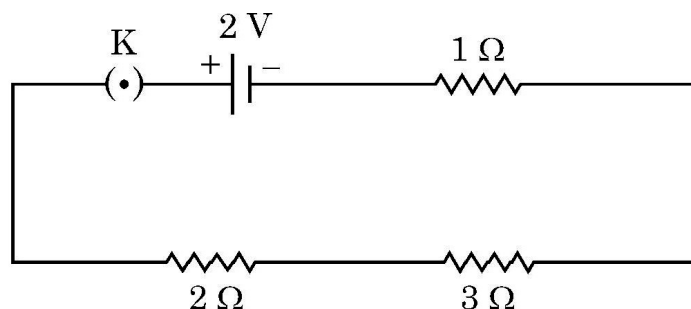

26. उन पदार्थों के लिए उपयोग होने वाले पद का नाम लिखिए जिनका विखण्डन जैविक प्रक्रियाओं द्वारा नहीं किया जा सकता है। उन दो तरीकों का उल्लेख कीजिए जिनसे वे किसी पारितंत्र के विभिन्न घटकों को हानि पहुँचाते हैं।

2

### खण्ड – ग

प्रश्न संख्या 27 से 33 लघु उत्तरीय प्रश्न हैं।

27. (a) निम्नलिखित के लिए कारण दीजिए :
- (i) फुफ्फुस में कूपिकाओं में रुधिर वाहिकाओं का विस्तीर्ण जाल होता है।
- (ii) रुधिर में श्वसन वर्णक ऑक्सीजन लेता है, कार्बन डाइऑक्साइड नहीं।
- (iii) मानव शरीर में अवायवीय श्वसन के समय अन्तिम उत्पाद के रूप में  $CO_2$  के स्थान पर 3-कार्बन अणु बनता है।

3

### अथवा

27. (b) (i) मानव पाचन तंत्र में आहार नली के हर भाग में होने वाली गति का नाम लिखिए। ये गतियाँ पाचन में किस प्रकार सहायता करती हैं ?
- (ii) मानव शरीर में पित्त रस कहाँ संचित होता है ? पित्त रस की दो भूमिकाओं की सूची बनाइए।

3

28. (a) यदि परागण नहीं होता है तो आवृतबीजीयों के पुष्पों में निषेचन क्यों नहीं हो सकता है ? निषेचन के पश्चात पुष्प में युग्मनज कहाँ स्थित होता है ? यह विकसित होकर क्या बन जाता है ?
- (b) पुष्प के उन भागों के नाम लिखिए जो वही कार्य करते हैं जो जन्तुओं के नीचे दिए गए भाग करते हैं :
- (i) वृषण (ii) अंडाशय

3

29. (a) किसी बीकर जिसमें अम्लीकृत जल भरा है तथा जिसमें दो इलेक्ट्रोड हैं (जिन्हें जल से भरी परखनलियों से ढक दिया गया है) उसमें विद्युत धारा प्रवाहित करने पर होने वाले दो प्रेक्षणों का उल्लेख कीजिए।
- (b) ऋणावेशित इलेक्ट्रोड पर एकत्रित गैस के द्रव्यमान और धनावेशित इलेक्ट्रोड पर एकत्रित गैस के द्रव्यमान का अनुपात लिखिए।

3

30. कॉपर के विद्युत-अपघटनी परिष्करण को दर्शाने के लिए नामांकित आरेख खींचिए। उल्लेख कीजिए कि क्या होता है जब इस प्रकरण में विद्युत-अपघट्य से विद्युत धारा प्रवाहित की जाती है।

3

31. (a) कोई बिम्ब 12 cm फोकस दूरी के किसी अवतल दर्पण के सामने स्थित है। यदि बिम्ब की दर्पण के ध्रुव से दूरी 8 cm है, तो दर्पण सूत्र का उपयोग करके बनने वाले प्रतिबिम्ब की स्थिति निर्धारित कीजिए। इस प्रकरण में अपने उत्तर की पुष्टि के लिए नामांकित किरण आरेख खींचिए।

3

### अथवा

2131/2/2

14



26. Name the term used for the materials which **cannot** be broken down by biological processes. Give two ways by which they harm various components of an ecosystem. 2

### SECTION – C

**Q. Nos. 27 to 33 are short answer questions.**

27. (a) Give reasons for the following : 3
- (i) Alveoli in lungs are richly supplied with blood capillaries.
  - (ii) Respiratory pigment in the blood takes up oxygen and not carbon dioxide.
  - (iii) During anaerobic respiration, a 3-carbon molecule is formed as an end product instead of  $\text{CO}_2$  in human beings.

**OR**

27. (b) (i) Name the movements that occur all along the gut in human digestive system. How do they help in digestion ? 3
- (ii) Where is bile juice stored in human body ? List two roles of bile juice.
28. (a) In angiosperms why fertilisation cannot take place in flowers if pollination does not take place ? Where is zygote located in a flower after fertilisation ? What does it develop into ? 3
- (b) Write the names of those parts of a flower which serve the same function as the following do in animals :
- (i) testis (ii) ovary
29. (a) State any two observations when an electric current is passed through acidulated water, in a container having each electrode covered by test tubes filled with water. 3
- (b) Write the ratio of the mass of the gas collected at the cathode to the mass of the gas collected at the anode.
30. Draw a labelled diagram to show electrolytic refining of copper. State what happens when electric current is passed through the electrolyte taken in this case. 3
31. (a) An object is placed in front of a concave mirror of focal length 12 cm. If distance of the object from the pole of the mirror is 8 cm, then use mirror formula to determine the position of the image formed. Draw a labelled ray diagram to justify your answer in this case. 3

**OR**

31. (b) (i) किसी दर्पण द्वारा बना किसी बिम्ब का प्रतिबिम्ब वास्तविक, उल्टा तथा  $-1$  आवर्धन का है। यदि प्रतिबिम्ब दर्पण से 30 cm दूरी पर है तो बिम्ब कहाँ स्थित है ? अपने उत्तर की पुष्टि के लिए कारण दीजिए। 3
- (ii) यदि बिम्ब को दर्पण की ओर 15 cm स्थानान्तरित कर दिया जाए, तो प्रतिबिम्ब कहाँ बनेगा ? अपने उत्तर की पुष्टि के लिए बिम्ब की नयी स्थिति के लिए किरण आरेख खींचिए।
32. (a) फ्लेमिंग का वामहस्त नियम लिखिए। इस नियम का अनुप्रयोग करके आरेख में दर्शाए अनुसार किसी एकसमान चुम्बकीय क्षेत्र में स्थित किसी सीधे धारावाही चालक AB पर लगे बल की दिशा निर्धारित कीजिए। 3

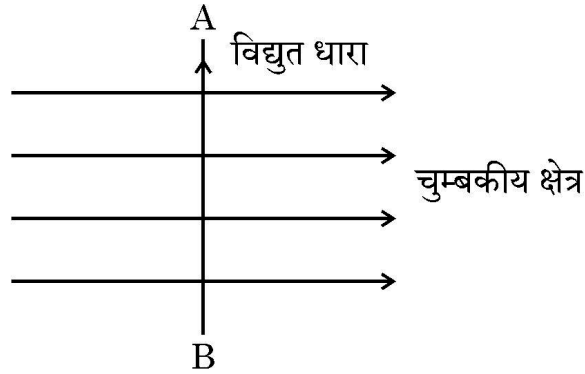

- (b) क्या होगा यदि इसी चुम्बकीय क्षेत्र में जिस दिशा में चालक AB में विद्युत धारा प्रवाहित हो रही है उसी दिशा में कोई इलेक्ट्रॉन प्रवेश करता है ? अपने उत्तर की पुष्टि के लिए कारण दीजिए।

33. अपनी फसलों की सुरक्षा के लिए पीड़कनाशियों का उपयोग विभिन्न पोषी स्तरों के जीवों, विशेषकर मानव जाति को प्रभावित करता है। इसमें होने वाली परिघटना का नाम लिखिए और व्याख्या कीजिए कि यह किस प्रकार होता है। 3

#### खण्ड – घ

**प्रश्न संख्या 34 से 36 दीर्घ उत्तरीय प्रश्न हैं।**

34. (a) किसी उत्तल लेंस का ऊपरी आधा भाग काले कागज से ढका है। इस लेंस से  $2F$  की दूरी पर स्थित किसी बिम्ब का प्रतिबिम्ब बनना दर्शाने के लिए किरण आरेख खींचिए। बनने वाले प्रतिबिम्ब की स्थिति और प्रकृति का उल्लेख कीजिए। यदि लेंस से काले कागज को हटा दिया जाए तो प्रतिबिम्ब में अब दिखाई देने योग्य अन्तर का उल्लेख कीजिए। अपने उत्तर की पुष्टि के लिए कारण दीजिए। 5
- (b) कोई बिम्ब 15 cm फोकस दूरी के किसी अवतल लेंस के प्रकाशिक केन्द्र से 30 cm दूरी पर स्थित है। लेंस-सूत्र का उपयोग करके प्रतिबिम्ब की लेंस के प्रकाशिक केन्द्र से दूरी ज्ञात कीजिए।



31. (b) (i) The image of an object formed by a mirror is real, inverted and is of magnification-1. If the image is at a distance of 30 cm from the mirror, where is the object placed ? Give reason to justify your answer. 3
- (ii) Where would the image be if the object is moved 15 cm towards the mirror ? Draw ray diagram for the new position of the object to justify your answer.
32. (a) State Fleming's left hand rule. Apply this rule to determine the direction of force experienced by a straight current carrying conductor AB placed in a uniform magnetic field as shown. 3

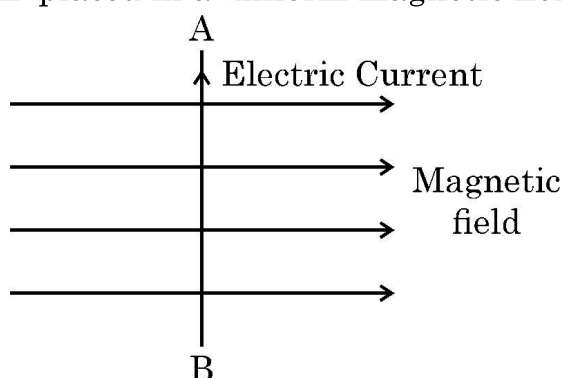

- (b) What will happen to an electron which enters in the same field in the same direction in which the current is flowing in the conductor AB ? Give reason to justify your answer.
33. Use of pesticides to protect our crops affect organisms at various trophic levels especially human beings. Name the phenomenon involved and explain how does it happen. 3

### SECTION – D

**Q. No. 34 to 36 are long answer questions.**

34. (a) Upper half of a convex lens is covered with a black paper. Draw a ray diagram to show the formation of image of an object placed at a distance of  $2F$  from such a lens. Mention the position and nature of the image formed. State the observable difference in the image obtained if the lens is uncovered. Give reason to justify your answer. 5
- (b) An object is placed at a distance of 30 cm from the optical centre of a concave lens of focal length 15 cm. Use lens formula to determine the distance of the image from the optical centre of the lens.

35. (a) (i) कारण दीजिए कि कार्बन क्यों न तो  $C^{4+}$  धनायन बना सकता है और न ही  $C^{4-}$  ऋणायन बना सकता है, परन्तु यह सहसंयोजी आबन्ध बनाता है। 5
- (ii) कार्बन-यौगिकों की समजातीय श्रेणी किसे कहते हैं ? एल्डिहाइडों की समजातीय श्रेणी के किन्हीं दो क्रमागत सदस्यों के आण्विक सूत्र लिखिए।
- (iii) साइक्लोहेक्सेन ( $C_6H_{12}$ ) के अणु की संरचना खींचिए।

**अथवा**

35. (b) (i) प्रकार्यात्मक समूह  $-OH$  के औद्योगिक दृष्टि से महत्वपूर्ण कार्बन यौगिक का नाम और उसका आण्विक सूत्र लिखिए। 5
- (ii) इस यौगिक की निम्नलिखित से अभिक्रिया के रासायनिक समीकरण लिखिए :
- (1) सोडियम धातु
  - (2) आधिक्य सांद्र सल्फ्यूरिक अम्ल
  - (3) किसी अम्ल उत्प्रेरक की उपस्थिति में एथेनॉइक अम्ल
  - (4) अम्लीकृत पोटैशियम डाइक्रोमेट
- प्रत्येक प्रकरण में बनने वाले उत्पाद का नाम भी लिखिए।

36. (a) (i) पादपों एवं जन्तुओं में होने वाले हॉर्मोनी समन्वयों के बीच विभेदन कीजिए। 5
- (ii) मानव मस्तिष्क का कौन सा भाग निम्नलिखित के लिए उत्तरदायी है ?
- (1) बोधगम्यता
  - (2) साईकिल चलाना
  - (3) उल्टी आना
  - (4) भूख पर नियंत्रण
- (iii) यांत्रिक आघातों (चोटों) से मस्तिष्क और मेरुरज्जु की सुरक्षा किस प्रकार होती है ?

**अथवा**

36. (b) (i) अनुवर्तनी गति किसे कहते हैं ? उस पादप हॉर्मोन का एक उदाहरण दीजिए (1) जो वृद्धि का संदमन करता है, तथा (2) जो कोशिका विभाजन को प्रेरित करता है। 5
- (ii) स्पर्श की अनुक्रिया में मटर के पौधे के प्रतान की दैशिक गति की व्याख्या कीजिए। इस गति के लिए उत्तरदायी हॉर्मोन का नाम लिखिए।



35. (a) (i) Give reason why carbon can neither form  $C^{4+}$  cations nor  $C^{4-}$  anions but form covalent compounds. 5
- (ii) What is homologous series of carbon compound ? Write the molecular formula of any two consecutive members of homologous series of aldehydes.
- (iii) Draw the structure of the molecule of cyclohexane ( $C_6H_{12}$ ).

**OR**

35. (b) (i) Name a commercially important carbon compound having functional group  $-OH$  and write its molecular formula. 5
- (ii) Write chemical equation to show its reaction with
- (1) Sodium metal
  - (2) Excess conc. sulphuric acid
  - (3) Ethanoic acid in the presence of an acid catalyst
  - (4) Acidified potassium dichromate
- Also write the name of the product formed in each case.

36. (a) (i) Distinguish between hormonal co-ordination in plants and animals. 5
- (ii) Which part of the brain is responsible for –
- (1) intelligence
  - (2) riding a bicycle
  - (3) vomiting
  - (4) controlling hunger
- (iii) How is brain and spinal-cord protected against mechanical injuries ?

**OR**

36. (b) (i) What are tropic movements ? Give an example of a plant hormone which (1) inhibits growth and (2) promotes cell division. 5
- (ii) Explain directional movement of a tendril in pea plant in response to touch. Name the hormone responsible for this movement.



## खण्ड – ड

प्रश्न संख्या 37 से 39 स्रोत आधारित/प्रकरण आधारित प्रश्न हैं, जिनमें 2 से 3 लघु उप-भाग हैं। इनमें से एक उप-भाग में आन्तरिक चयन प्रदान किया गया है।

37. जब किसी विशुद्ध रूप से प्रतिरोधक परिपथ में विद्युत धारा प्रवाहित होती है, तो विद्युत ऊर्जा पूर्ण रूप से ऊष्मीय ऊर्जा में परिवर्तित हो जाती है। यह पाया गया है कि परिपथ में उत्पन्न ऊष्मा की मात्रा (H) (i) धारा के वर्ग ( $I^2$ ) के, (ii) चालक के प्रतिरोध (R) के तथा (iii) चालक में जितने समय तक धारा प्रवाहित होती है उस समय (t) के अनुक्रमानुपाती होती है। दूसरे शब्दों में,  $H = I^2Rt$ । विद्युत युक्तियाँ जैसे विद्युत फ्यूज, विद्युत हीटर, विद्युत इस्तरी आदि, ये सभी विद्युत धारा के तापन प्रभाव पर आधारित हैं।
- (a) तापन अवयवों की दो विशेषताओं की सूची बनाइए। 1
- (b) विद्युत फ्यूज की दो विशेषताओं की सूची बनाइए। 1
- (c) उस नियम का नाम लिखिए जिस पर कोई विद्युत फ्यूज कार्य करता है। व्याख्या कीजिए कि विद्युत फ्यूज का तार किस प्रकार आकस्मिक उत्पन्न होने वाली उच्च विद्युत धारा से विद्युत साधित्रों को क्षतिग्रस्त होने से बचाने में सक्षम होता है। 2

## अथवा

- (c) किसी विद्युत हीटर की शक्ति 1100 W है। यदि इस हीटर के दोनों सिरों के बीच विभवान्तर 220 V है, तो परिपथ से प्रवाहित धारा ज्ञात कीजिए। इस परिपथ में संयोजित 5 A अनुमतांक के विद्युत फ्यूज का क्या होगा? 2
38. लवणों की हमारे दैनिक जीवन में अत्यन्त महत्वपूर्ण भूमिका होती है। सोडियम क्लोराइड जिसे साधारण नमक कहते हैं, का उपयोग लगभग सभी रसोइघरों में होता है। बेकिंग सोडा भी एक लवण ही है जिसका उपयोग भोजन को शीघ्र पकाने के साथ-साथ बेकिंग उद्योगों में भी किया जाता है। लवणों का वर्गीकरण उनमें उपस्थित ऋणायनों और धनायनों के आधार पर किया जाता है।
- (a) उस अम्ल और उस क्षारक की पहचान कीजिए जिनसे मिलकर सोडियम क्लोराइड बनता है। 1
- (b) कैल्सियम सल्फेट में उपस्थित ऋणायन और धनायन ज्ञात कीजिए। 1
- (c) “सोडियम क्लोराइड और धोने का सोडा एक ही परिवार के लवण हैं।” इस कथन की पुष्टि कीजिए। 2

## अथवा

- (c) pH स्केल की परिभाषा दीजिए। पोटैशियम हाइड्रॉक्साइड और सल्फ्यूरिक अम्ल की अभिक्रिया से बनने वाले लवण का नाम तथा इस लवण के जलीय विलयन का pH मान लिखिए। 2



## SECTION – E

**Q. No. 37 to 39 are case based / data based questions with 2 to 3 short sub-parts. Internal choice is provided in one of these sub-parts.**

37. When electric current flows in a purely resistive circuit electrical energy gets fully converted into heat energy. The amount of heat produced (H) in the circuit is found to be directly proportional to (i) the square of current ( $I^2$ ) (ii) the resistance (R) of the conductor and (iii) the time (t) for which current flows. In other words  $H = I^2Rt$ . Electrical devices such an electric fuse, electric heater, electric iron etc. are all based on this effect called heating effect of electric current. 4
- (a) List two properties of heating elements. 1
- (b) List two properties of electric fuse. 1
- (c) Name the principle on which an electric fuse works. Explain how a fuse wire is capable of saving electrical appliances from getting damaged due to accidentally produced high currents. 2

**OR**

- (c) The power of an electric heater is 1100 W. If the potential difference between the two terminals of the heater is 220 V, find the current flowing in the circuit. What will happen to an electric fuse of rating 5 A connected in this circuit ? 2
38. Salts play a very important role in our daily life. Sodium chloride which is known as common salt is used almost in every kitchen. Baking soda is also a salt used in faster cooking as well as in baking industry. The family of salts is classified on the basis of cations and anions present in them. 4
- (a) Identify the acid and base from which Sodium chloride is formed. 1
- (b) Find the cation and the anion present in Calcium sulphate. 1
- (c) “Sodium chloride and washing soda both belong to the same family of salts.” Justify this statement. 2

**OR**

- (c) Define the term pH scale. Name the salt obtained by the reaction of Potassium hydroxide and Sulphuric acid and give the pH value of its aqueous solution. 2

39. अलैंगिक जनन द्वारा संतति उत्पन्न करने में एकल जनक भाग लेता है और इसमें युग्मनज नहीं बनते हैं। यह निम्नलिखित विधाओं द्वारा होता है – विखण्डन, मुकुलन, खण्डन, बीजाणु समासंघ तथा पुनरुद्भवन (पुनर्जनन)। इनमें से पुनर्जनन जैसी विधा में प्लैनेरिया 'A' क्षैतिजतः तीन भागों में – L, M और N कट गया है तथा प्लैनेरिया 'B' ऊर्ध्वाधरतः दो भागों – O और P में कट गया है।

4

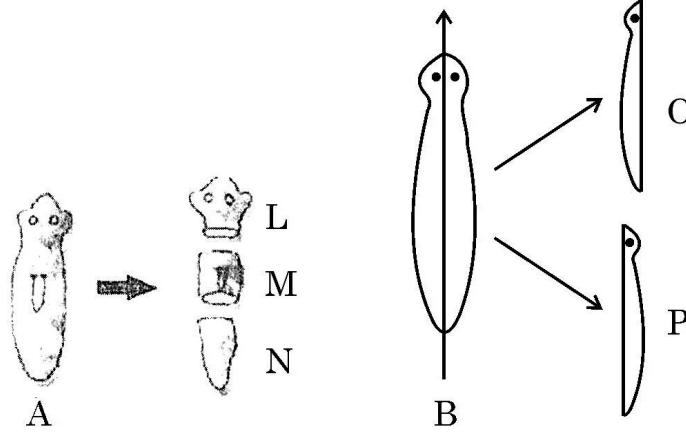

- (a) इन दोनों प्लैनेरियाओं के कौन से भाग पुनरुद्भवन द्वारा विकसित होकर पूर्ण जीव का निर्माण कर लेंगे ?
- (b) प्लैनेरिया की ही भाँति जनन की समान विधा को अपनाने वाले किसी अन्य जीव का उदाहरण दीजिए।
- (c) पुनरुद्भवन में “विकास” का क्या अर्थ है ?

1

1

2

**अथवा**

- (c) पुनरुद्भवन और खण्डन के बीच विभेदन कीजिए।

2

39. Asexual reproduction involves a single parent to produce offsprings without the formation of gametes. It occurs by the following ways : Fission, Budding, Fragmentation, Spore formation and Regeneration. In one of the methods like regeneration, Planaria A is cut horizontally into three pieces – L, M and N and Planaria B is cut vertically into two equal halves – O and P.

4

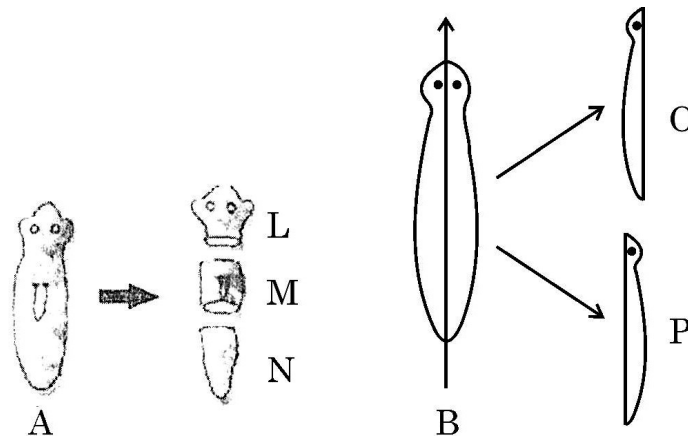

- (a) Which of the cut pieces of the two Planaria could regenerate to form a complete organism ? 1
- (b) Give an example of another organism which follows the same mode of reproduction as Planaria. 1
- (c) What is the meaning of 'development' in regeneration ? 2

**OR**

- (c) Differentiate between regeneration and fragmentation. 2

2131/2/2

**111 B**

24





**Marking Scheme**  
**Strictly Confidential**  
**(For Internal and Restricted use only)**  
**Secondary School Examination, 2024**  
**SUBJECT NAME SCIENCE (086) (Q.P. CODE 31/2/1)**

General Instructions: -

1	You are aware that evaluation is the most important process in the actual and correct assessment of the candidates. A small mistake in evaluation may lead to serious problems which may affect the future of the candidates, education system and teaching profession. To avoid mistakes, it is requested that before starting evaluation, you must read and understand the spot evaluation guidelines carefully.
2	“Evaluation policy is a confidential policy as it is related to the confidentiality of the examinations conducted, Evaluation done and several other aspects. Its’ leakage to public in any manner could lead to derailment of the examination system and affect the life and future of millions of candidates. Sharing this policy/document to anyone, publishing in any magazine and printing in News Paper/Website etc may invite action under various rules of the Board and IPC.”
3	Evaluation is to be done as per instructions provided in the Marking Scheme. It should not be done according to one’s own interpretation or any other consideration. Marking Scheme should be strictly adhered to and religiously followed. However, while evaluating, answers which are based on latest information or knowledge and/or are innovative, they may be assessed for their correctness otherwise and due marks be awarded to them. In class-X, while evaluating two competency-based questions, please try to understand given answer and even if reply is not from marking scheme but correct competency is enumerated by the candidate, due marks should be awarded.
4	The Marking scheme carries only suggested value points for the answers These are in the nature of Guidelines only and do not constitute the complete answer. The students can have their own expression and if the expression is correct, the due marks should be awarded accordingly.
5	The Head-Examiner must go through the first five answer books evaluated by each evaluator on the first day, to ensure that evaluation has been carried out as per the instructions given in the Marking Scheme. If there is any variation, the same should be zero after deliberation and discussion. The remaining answer books meant for evaluation shall be given only after ensuring that there is no significant variation in the marking of individual evaluators.
6	Evaluators will mark(√) wherever answer is correct. For wrong answer CROSS ‘X’ be marked. Evaluators will not put right (√)while evaluating which gives an impression that answer is correct and no marks are awarded. This is most common mistake which evaluators are committing.
7	If a question has parts, please award marks on the right-hand side for each part. Marks awarded for different parts of the question should then be totaled up and written in the left-hand margin and encircled. This may be followed strictly.
8	If a question does not have any parts, marks must be awarded in the left-hand margin and encircled. This may also be followed strictly.
9	If a student has attempted an extra question, answer of the question deserving more marks should be retained and the other answer scored out with a note “Extra Question”.

10	No marks to be deducted for the cumulative effect of an error. It should be penalized only once.
11	A full scale of marks 0 – 80 (example 0 to 80/70/60/50/40/30 marks as given in Question Paper) has to be used. Please do not hesitate to award full marks if the answer deserves it.
12	Every examiner has to necessarily do evaluation work for full working hours i.e., 8 hours every day and evaluate 20 answer books per day in main subjects and 25 answer books per day in other subjects (Details are given in Spot Guidelines). This is in view of the reduced syllabus and number of questions in question paper.
13	Ensure that you do not make the following common types of errors committed by the Examiner in the past:- Leaving answer or part thereof unassessed in an answer book. Giving more marks for an answer than assigned to it. Wrong totaling of marks awarded on an answer. Wrong transfer of marks from the inside pages of the answer book to the title page. Wrong question wise totaling on the title page. Wrong totaling of marks of the two columns on the title page. Wrong grand total. Marks in words and figures not tallying/not same. Wrong transfer of marks from the answer book to online award list. Answers marked as correct, but marks not awarded. (Ensure that the right tick mark is correctly and clearly indicated. It should merely be a line. Same is with the X for incorrect answer.) Half or a part of answer marked correct and the rest as wrong, but no marks awarded.
14	While evaluating the answer books if the answer is found to be totally incorrect, it should be marked as cross (X) and awarded zero (0) Marks.
15	Any unassessed portion, non-carrying over of marks to the title page, or totaling error detected by the candidate shall damage the prestige of all the personnel engaged in the evaluation work as also of the Board. Hence, in order to uphold the prestige of all concerned, it is again reiterated that the instructions be followed meticulously and judiciously.
16	The Examiners should acquaint themselves with the guidelines given in the “Guidelines for Spot Evaluation” before starting the actual evaluation.
17	Every Examiner shall also ensure that all the answers are evaluated, marks carried over to the title page, correctly totaled and written in figures and words.
18	The candidates are entitled to obtain photocopy of the Answer Book on request on payment of the prescribed processing fee. All Examiners/Additional Head Examiners/Head Examiners are once again reminded that they must ensure that evaluation is carried out strictly as per value points for each answer as given in the Marking Scheme.



**MARKING SCHEME**  
**Secondary School Examination, 2024**  
**SCIENCE (Subject Code-086)**  
**[ Paper Code: 31/2/1]**

**Maximum Marks: 80**

Q. No.	EXPECTED ANSWER / VALUE POINTS	Marks	Total Marks
<b>SECTION A</b>			
1	(D)/ is exothermic reaction and pH of the solution formed is more than 7.	1	1
2	(C) /Tartaric acid	1	1
3	(B)/ Burning of coal	1	1
4	(B)/ Al <sub>2</sub> O <sub>3</sub>	1	1
5	(D) /(b) and (d)	1	1
6	(C) /SO <sub>2</sub> is an oxidising agent and H <sub>2</sub> S is a reducing agent	1	1
7	(A) /(a) and (b)	1	1
8	(C) /(b) and (c)	1	1
9	(A) /Pituitary	1	1
10	(B)/ Lifted ribs and flattened diaphragm	1	1
11	(C) /Budding	1	1
12	(C) /Tt and tt	1	1
13	(A)/ (a) and (b)	1	1
14	(A) /1 Ω	1	1
15	(C) /R <sub>3</sub> > R <sub>2</sub> > R <sub>1</sub>	1	1
16	(B) /direction of current flowing through it.	1	1
17	(B) /Both Assertion (A) and Reason (R) are true but Reason (R) is <i>not</i> the correct explanation of Assertion (A).	1	1
18	(B) / Both Assertion (A) and Reason (R) are true but Reason (R) is <i>not</i> the correct explanation of Assertion (A).	1	1
19	(C) /Assertion (A) is true, but Reason (R) is false.	1	1
20	(D)/ Assertion (A) is false, but Reason (R) is true.	1	1
<b>SECTION B</b>			
21	(a) <ul style="list-style-type: none"> <li>• Exchange of ions can take place only in a double displacement(precipitation) reaction where one of the products gets precipitated.</li> <li>• Reaction:  <math display="block">\text{Na}_2\text{SO}_4 (\text{aq}) + \text{BaCl}_2 (\text{aq}) \rightarrow \text{BaSO}_4 (\text{s}) + 2\text{NaCl}(\text{aq})</math> <p style="text-align: center;">(precipitate)</p> <p style="text-align: center;">(Or Any Other Reaction)</p> <p style="text-align: center;"><b>OR</b></p> </li> </ul>	½  1½	

	(b)						
	<table border="1"> <tr> <td>Displacement reaction:</td> <td>Double displacement reaction</td> </tr> <tr> <td>More reactive metal displaces a less reactive metal. / No exchange of ions takes place. <math>CuSO_4 + Fe \rightarrow FeSO_4 + Cu</math></td> <td>an exchange of ions between the reactants takes place. <math>Na_2SO_4 + BaCl_2 \rightarrow BaSO_4 + 2NaCl</math></td> </tr> </table>	Displacement reaction:	Double displacement reaction	More reactive metal displaces a less reactive metal. / No exchange of ions takes place. $CuSO_4 + Fe \rightarrow FeSO_4 + Cu$	an exchange of ions between the reactants takes place. $Na_2SO_4 + BaCl_2 \rightarrow BaSO_4 + 2NaCl$	1	
Displacement reaction:	Double displacement reaction						
More reactive metal displaces a less reactive metal. / No exchange of ions takes place. $CuSO_4 + Fe \rightarrow FeSO_4 + Cu$	an exchange of ions between the reactants takes place. $Na_2SO_4 + BaCl_2 \rightarrow BaSO_4 + 2NaCl$						
	(Or any other reaction)	1					
			2				
22	<ul style="list-style-type: none"> <li>• Translocation</li> <li>• Transport of soluble products or food prepared by photosynthesis, through phloem in the sieve tubes with the help of companion cells, both in upward and downward directions by utilising energy.</li> </ul>	½					
		1½					
			2				
23	<ul style="list-style-type: none"> <li>• Every germ cell takes one chromosome from each pair, either maternal or paternal origin.</li> <li>• When two germ cells from parents combine, it will restore the original number of chromosomes in the progeny ensuring the stability of DNA of the species.</li> </ul>	1					
		1					
			2				
24	<p>Laws of Refraction of light :</p> <p>(i) The incident ray, the refracted ray and the normal to the interface of two transparent media at the point of incidence, all lie in the same plane.</p> <p>(ii) The ratio of the sine of angle of incidence to the sine of angle of refraction is a constant, for the light of a given colour and for the given pair of media.</p> <p><b>Note:</b> If a student writes <math>\frac{\sin i}{\sin r} = \text{constant}</math> instead of statement, award ½ mark only)</p> <p style="text-align: center;"><b>OR</b></p> <p>Absolute refractive index of a medium is the ratio of speed of light in air/vacuum to the speed of light in the given medium.</p> <p>Given:</p>	1					
		1					
			1				

	$c = 3 \times 10^8 \text{ m/s}; n_m = 1.5; v_m = ?$  Absolute refractive index of a medium ( $n_m$ )  $= \frac{\text{speed of light in vacuum}}{\text{speed of light in medium}} = \frac{c}{v_m}$  $v_m = \frac{c}{n_m} = 2 \times 10^8 \text{ m/s}$	1/2	1/2	2
25	$R_s = R_1 + R_2 + R_3$ $= 1 + 2 + 3 = 6 \Omega$  $I = \frac{V}{R}$ $= \frac{2V}{6\Omega} = \frac{1}{3} \text{ A}$  $V = IR$ $= \frac{1}{3} \text{ A} \times 3(\Omega) = 1 \text{ V}$	1/2	1/2	1/2
26	<ul style="list-style-type: none"> <li>• Non-biodegradable substances</li> <li>• <b>Two ways:</b> <ol style="list-style-type: none"> <li>(i) They are inert and persist in the environment for long time and cause pollution.</li> <li>(ii) Cause Biological magnification</li> <li>(iii) Affect the fertility of soil</li> </ol> </li> </ul> <p style="text-align: right;"><b>(any two) (or any other)</b></p>	1	1/2	1/2
<b>SECTION C</b>				
27	<ul style="list-style-type: none"> <li>• Bubbles of hydrogen gas formed stick to the surface of calcium and make it lighter than water.</li> </ul> $Ca(s) + 2H_2O(l) \longrightarrow Ca(OH)_2(aq) + H_2(g)$ <ul style="list-style-type: none"> <li>• The solution formed turns milky.</li> </ul> $Ca(OH)_2(aq) + CO_2(g) \longrightarrow CaCO_3(s) + H_2O(l)$	1/2	1	1/2
		1		3

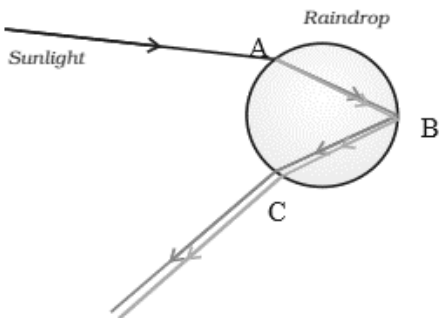

	<p>embryo.</p> <ul style="list-style-type: none"> <li>Embryo is implanted in the lining of the uterus, where it continues to grow and develops organs to become a foetus.</li> <li>Role of Placenta: <ul style="list-style-type: none"> <li>(i) Provides a large surface area for glucose and oxygen to pass from the mother to the embryo.</li> <li>(ii) Waste generated by the embryo will be removed by transferring them into the mother's blood.</li> </ul> </li> </ul>	<p><math>\frac{1}{2}</math></p> <p><math>\frac{1}{2}, \frac{1}{2}</math></p> <p><math>\frac{1}{2}</math></p> <p><math>\frac{1}{2}</math></p>	<p>3</p>
31	<p>(a)</p> <ul style="list-style-type: none"> <li>Ability of the eye lens to adjust its focal length.</li> <li>Ciliary muscles</li> <li>(i) While focusing on nearby objects ciliary muscles contract, eye lens becomes thick and its focal length decreases.</li> <li>(ii) While focusing on distant objects ciliary muscles relax, eye lens becomes thin and its focal length increases.</li> </ul> <p style="text-align: center;"><b>OR</b></p> <p>(b)</p>  <p style="text-align: center;"><b>Diagram Reference figure 10.8 page 167 NCERT</b></p> <p style="text-align: center;">3 Labellings (A, B, C)</p> <ul style="list-style-type: none"> <li>Two conditions: <ul style="list-style-type: none"> <li>(i) Presence of tiny water droplets in the atmosphere.</li> <li>(ii) Position of Sun at the back(behind) the observer.</li> </ul> </li> </ul>	<p>1</p> <p>1</p> <p><math>\frac{1}{2}</math></p> <p><math>\frac{1}{2}</math></p> <p><math>\frac{1}{2}</math></p> <p><math>\frac{1}{2}</math></p> <p><math>\frac{1}{2} \times 3</math></p> <p><math>\frac{1}{2}</math></p> <p><math>\frac{1}{2}</math></p>	<p>3</p>

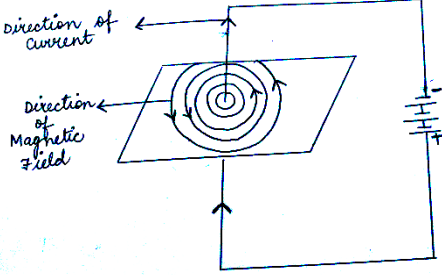
32	<ul style="list-style-type: none"> <li>  <p style="text-align: center;"><b>Direction of Current</b> <b>Direction of magnetic field lines</b></p> </li> <li> <p><b>Right-Hand Thumb Rule :</b> When a current-carrying straight conductor is being held in right-hand such that the thumb points towards the direction of current, then fingers will wrap around the conductor in the direction of the magnetic field lines.</p> </li> </ul>	1  1/2 1/2  1	3
33	<p>Phenomenon – Biological Magnification /Biomagnification</p> <ul style="list-style-type: none"> <li>Pesticides are washed down into the soil and water bodies.</li> <li>From the soil pesticides are absorbed by crop plants along with water and minerals and enter the food chain.</li> <li>These chemicals are non-biodegradable and get accumulated progressively at each trophic level.</li> <li>As human beings occupy the top level in any food chain, the maximum concentration of these chemicals gets accumulated in our bodies.</li> </ul>	1  1/2  1/2  1/2	3
<b>SECTION D</b>			
34	<p>(a)</p> <p>(i)</p> <ul style="list-style-type: none"> <li>Carbon cannot form <math>C^{4+}</math> cations because removal of 4 electrons from a carbon atom would require a large amount of energy and it cannot form <math>C^{4-}</math> anion because it would be difficult for the nucleus with 6 protons to hold 10 electrons.</li> <li>Thus it shares electrons to form covalent compounds.</li> </ul> <p>(ii)</p> <ul style="list-style-type: none"> <li>A series of compounds in which the same functional group substitutes for hydrogen in a carbon chain / series of compounds having same functional group and similar chemical properties.</li> <li><math>CH_3CHO</math>, <math>C_2H_5CHO</math> (any other consecutive members)</li> </ul> <p>(iii) Structure of cyclohexane (<math>C_6H_{12}</math>)</p>	1  1  1  1/2, 1/2	



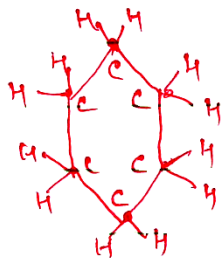

OR

(b)

(i) Ethanol –  $C_2H_5OH$

(ii)

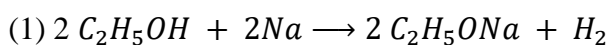

**Sodium Ethoxide**

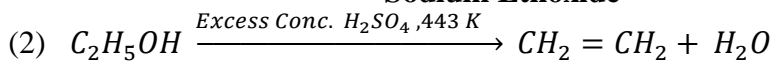

**Ethene**

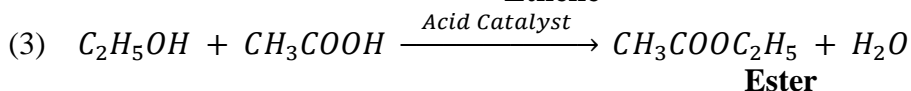

**Ester**

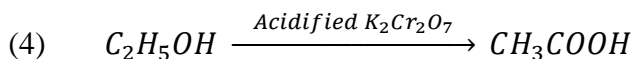

**Ethanoic acid**

**NOTE: Name of the product for each reaction is given in bold letters under the reaction.**

35

(a) (i)

Hormonal coordination in Plants	Hormonal coordination in Animals
1) By simple diffusion	Transported through blood to the target organ
2) No specialised glands involved.	Hormone released by Endocrine glands.

- (ii) (1) Cerebrum/forebrain,  
 (2) cerebellum/hindbrain  
 (3) medulla/ hindbrain  
 (4) hypothalamus/forebrain.

- (iii) Brain – Bony box/skull/cranium/fluid filled balloon in skull,  
 Spinal cord – Backbone/Vertebral column.

OR

- (b) (i) Plant growth movements in response to stimuli in a particular

1

1/2, 1/2

1/2, 1/2

1/2, 1/2

1/2, 1/2

1/2, 1/2

5

1,1

1/2 x 4

1/2

1/2

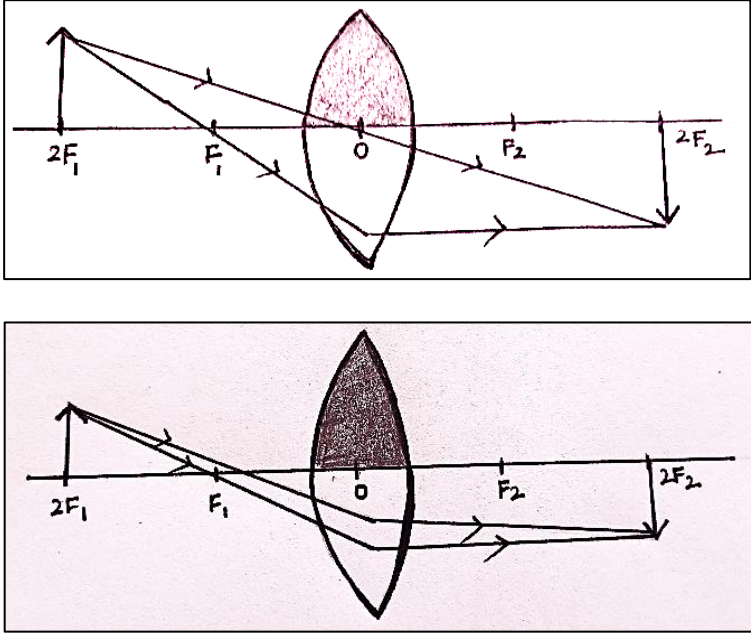

	<p>direction/directional movements due to light, gravity etc.</p> <p>(1) Plant growth inhibitor: Abscisic Acid</p> <p>(2) Promotes cell division – Cytokinins</p> <p>(ii) When the tendrils come in contact with any support, auxins move away from the point of contact of the support. More growth occurs on the side away from the support. As a result, unequal growth occurs on its two sides and thus tendrils coil/ circle around the support.</p> <ul style="list-style-type: none"> <li>• Auxins</li> </ul>	<p>1</p> <p>1/2</p> <p>1/2</p> <p>2</p> <p>1</p>	<p>5</p>
<p>36</p>	<p>(a)</p>  <p><b>Note: Any one of the above drawn ray diagrams should be marked.</b></p> <p>When the upper half of lens is covered:</p> <ul style="list-style-type: none"> <li>• Position of image: at 2F on the other side of the lens</li> <li>• Nature of image: Real and inverted</li> <li>• <b>Observable difference in the image, if the lens is uncovered</b> The brightness of the image will increase</li> <li>• <b>Reason:</b> More number of rays will pass through the lens to form the image.</li> </ul> <p>(b) Here <math>u = -30</math> cm, <math>f = -15</math> cm, <math>v = ?</math></p>	<p>1</p> <p>1/2</p> <p>1/2</p> <p>1/2</p> <p>1/2</p> <p>1/2</p>	

	$\frac{1}{v} - \frac{1}{u} = \frac{1}{f}$ $\frac{1}{v} = \frac{1}{f} + \frac{1}{u}$ $= \frac{1}{-15} + \frac{1}{-30}$ $v = -10 \text{ cm}$	<p>1/2</p> <p>1</p>	5				
<b>SECTION E</b>							
37	<p>(a) Acid – HCl, Base – NaOH</p> <p>(b) Cation <math>\text{Ca}^{2+}</math> Anion <math>\text{SO}_4^{2-}</math>,</p> <p>(c) Salts having same cations but different anions belong to the same family of salts. e.g. sodium chloride (NaCl) and Washing Soda/sodium carbonate (<math>\text{Na}_2\text{CO}_3</math>) both have <math>\text{Na}^+</math> as cation.</p> <p style="text-align: center;"><b>OR</b></p> <p>c) • A scale for measuring hydrogen ion (<math>\text{H}^+</math>) concentration in a solution is called pH scale.</p> <ul style="list-style-type: none"> <li>• Potassium Sulphate / <math>\text{K}_2\text{SO}_4</math></li> <li>• pH = 7</li> </ul>	<p>1/2, 1/2</p> <p>1/2, 1/2</p> <p>2</p> <p>1</p> <p>1/2</p> <p>1/2</p>	4				
38	<p>(a) All cut pieces of the two planaria will form a complete organism.</p> <p>(b) Hydra</p> <p>(c) Specialised cells proliferate to make a large number of cells. This mass of cells change to make different cell types and tissues. These changes take place in an organised sequence and is called development.</p> <p style="text-align: center;"><b>OR</b></p> <p>(c)</p> <table border="1" style="width: 100%;"> <thead> <tr> <th style="width: 50%;">Regeneration</th> <th style="width: 50%;">Fragmentation</th> </tr> </thead> <tbody> <tr> <td>Specialised cells proliferate to form new cells which multiply and form a a new individual</td> <td>Each piece/fragment grows by cell-to-cell division to form a new organism.</td> </tr> </tbody> </table>	Regeneration	Fragmentation	Specialised cells proliferate to form new cells which multiply and form a a new individual	Each piece/fragment grows by cell-to-cell division to form a new organism.	<p>1</p> <p>1</p> <p>2</p> <p>1,1</p>	4
Regeneration	Fragmentation						
Specialised cells proliferate to form new cells which multiply and form a a new individual	Each piece/fragment grows by cell-to-cell division to form a new organism.						
39	<p>(a)</p> <ul style="list-style-type: none"> <li>• Higher resistivity than pure metals</li> <li>• Do not oxidise (burn) at high temperature.</li> </ul>	1/2, 1/2					



	<p>(c)</p> <ul style="list-style-type: none"> <li>• Higher resistivity than pure metals</li> <li>• Low melting point.</li> </ul>	1/2 , 1/2	
	<p>(c)</p> <ul style="list-style-type: none"> <li>• Heating effect of electric current</li> </ul> <p>• When high current flows in the circuit accidentally, the fuse wire melts and breaks the circuit.</p>	1	
	<p><b>OR</b></p>		
	<p>(c) <math>P = 1100 \text{ W}; V = 220 \text{ V}, I = ?</math></p>		
	<p><math>P = VI</math></p>	1/2	
	<p><math>I = \frac{P}{V} = \frac{1100 \text{ W}}{220 \text{ V}} = 5\text{A}</math></p>	1/2	
	<ul style="list-style-type: none"> <li>• No effect on the fuse of 5A rating.</li> </ul>	1	4

\*\*\*\*\*

**Marking Scheme**  
**Strictly Confidential**  
**(For Internal and Restricted use only)**  
**Secondary School Examination, 2024**  
**SUBJECT NAME SCIENCE (086) (Q.P. CODE 31/2/2)**

General Instructions: -

1	You are aware that evaluation is the most important process in the actual and correct assessment of the candidates. A small mistake in evaluation may lead to serious problems which may affect the future of the candidates, education system and teaching profession. To avoid mistakes, it is requested that before starting evaluation, you must read and understand the spot evaluation guidelines carefully.
2	“Evaluation policy is a confidential policy as it is related to the confidentiality of the examinations conducted, Evaluation done and several other aspects. Its’ leakage to public in any manner could lead to derailment of the examination system and affect the life and future of millions of candidates. Sharing this policy/document to anyone, publishing in any magazine and printing in News Paper/Website etc may invite action under various rules of the Board and IPC.”
3	Evaluation is to be done as per instructions provided in the Marking Scheme. It should not be done according to one’s own interpretation or any other consideration. Marking Scheme should be strictly adhered to and religiously followed. However, while evaluating, answers which are based on latest information or knowledge and/or are innovative, they may be assessed for their correctness otherwise and due marks be awarded to them. In class-X, while evaluating two competency-based questions, please try to understand given answer and even if reply is not from marking scheme but correct competency is enumerated by the candidate, due marks should be awarded.
4	The Marking scheme carries only suggested value points for the answers These are in the nature of Guidelines only and do not constitute the complete answer. The students can have their own expression and if the expression is correct, the due marks should be awarded accordingly.
5	The Head-Examiner must go through the first five answer books evaluated by each evaluator on the first day, to ensure that evaluation has been carried out as per the instructions given in the Marking Scheme. If there is any variation, the same should be zero after deliberation and discussion. The remaining answer books meant for evaluation shall be given only after ensuring that there is no significant variation in the marking of individual evaluators.
6	Evaluators will mark(√) wherever answer is correct. For wrong answer CROSS ‘X’ be marked. Evaluators will not put right (√)while evaluating which gives an impression that answer is correct and no marks are awarded. This is most common mistake which evaluators are committing.
7	If a question has parts, please award marks on the right-hand side for each part. Marks awarded for different parts of the question should then be totaled up and written in the left-hand margin and encircled. This may be followed strictly.
8	If a question does not have any parts, marks must be awarded in the left-hand margin and encircled. This may also be followed strictly.
9	If a student has attempted an extra question, answer of the question deserving more marks should be retained and the other answer scored out with a note “Extra Question”.



10	No marks to be deducted for the cumulative effect of an error. It should be penalized only once.
11	A full scale of marks 0 – 80 (example 0 to 80/70/60/50/40/30 marks as given in Question Paper) has to be used. Please do not hesitate to award full marks if the answer deserves it.
12	Every examiner has to necessarily do evaluation work for full working hours i.e., 8 hours every day and evaluate 20 answer books per day in main subjects and 25 answer books per day in other subjects (Details are given in Spot Guidelines). This is in view of the reduced syllabus and number of questions in question paper.
13	Ensure that you do not make the following common types of errors committed by the Examiner in the past:- Leaving answer or part thereof unassessed in an answer book. Giving more marks for an answer than assigned to it. Wrong totaling of marks awarded on an answer. Wrong transfer of marks from the inside pages of the answer book to the title page. Wrong question wise totaling on the title page. Wrong totaling of marks of the two columns on the title page. Wrong grand total. Marks in words and figures not tallying/not same. Wrong transfer of marks from the answer book to online award list. Answers marked as correct, but marks not awarded. (Ensure that the right tick mark is correctly and clearly indicated. It should merely be a line. Same is with the X for incorrect answer.) Half or a part of answer marked correct and the rest as wrong, but no marks awarded.
14	While evaluating the answer books if the answer is found to be totally incorrect, it should be marked as cross (X) and awarded zero (0) Marks.
15	Any unassessed portion, non-carrying over of marks to the title page, or totaling error detected by the candidate shall damage the prestige of all the personnel engaged in the evaluation work as also of the Board. Hence, in order to uphold the prestige of all concerned, it is again reiterated that the instructions be followed meticulously and judiciously.
16	The Examiners should acquaint themselves with the guidelines given in the “Guidelines for Spot Evaluation” before starting the actual evaluation.
17	Every Examiner shall also ensure that all the answers are evaluated, marks carried over to the title page, correctly totaled and written in figures and words.
18	The candidates are entitled to obtain photocopy of the Answer Book on request on payment of the prescribed processing fee. All Examiners/Additional Head Examiners/Head Examiners are once again reminded that they must ensure that evaluation is carried out strictly as per value points for each answer as given in the Marking Scheme.



**MARKING SCHEME**  
**Secondary School Examination, 2024**  
**SCIENCE (Subject Code–086)**  
**[ Paper Code: 31/2/2]**

**Maximum Marks: 80**

Q. No.	EXPECTED ANSWER / VALUE POINTS	Marks	Total Marks
<b>SECTION A</b>			
1	(A) / (a) and (b)	1	1
2	(D) / 4	1	1
3	(B) / Burning of coal	1	1
4	(B) / Al <sub>2</sub> O <sub>3</sub>	1	1
5	(D) / Bronze	1	1
6	(A) / 5.1	1	1
7	(D) / is exothermic reaction and pH of the solution formed is more than 7.	1	1
8	(B) / Lifted ribs and flattened diaphragm	1	1
9	(A) / Pituitary	1	1
10	(C) / (b) and (c)	1	1
11	(D) / Rhizopus	1	1
12	(C) / Tt and tt	1	1
13	(B) / direction of current flowing through it.	1	1
14	(C) / ohm.metre	1	1
15	(C) / 2 Ω	1	1
16	(A) / (a) and (b)	1	1
17	(D) / (A) is false, but (R) is true.	1	1
18	(B) / Both (A) and (R) are true but (R) is <i>not</i> the correct explanation of (A).	1	1
19	(C) / (A) is true, but (R) is false.	1	1
20	(C) / A is true, but R is false	1	1
<b>SECTION B</b>			
21	<p>(a)</p> <ul style="list-style-type: none"> <li>When a single reactant breaks down to give simpler products.</li> </ul> $2 \text{FeSO}_4(s) \xrightarrow{\text{Heat}} \text{Fe}_2\text{O}_3(s) + \text{SO}_2(g) + \text{SO}_3(g)$ <p style="text-align: center;">OR</p> <p>(b) Balanced chemical equation is one in which the total number of atoms of each element remains same for reactants and products.</p> <ul style="list-style-type: none"> <li>Mass can neither be created nor destroyed in the chemical reaction./ To satisfy law of conservation of mass.</li> </ul>	<p>1</p> <p>1</p> <p>1</p> <p>1</p>	2



22	<p>(a)</p> <ul style="list-style-type: none"> <li>• Test Tube B</li> <li>• Blue-black</li> </ul> <p>(b) Starch is digested by saliva in test tube A, so no change in colour .  <b>Alternate answer</b>  Saliva contains enzyme which converts starch solution to sugar, so no change in colour.</p>	<p>½ ½</p> <p>1</p>	2								
23	<ul style="list-style-type: none"> <li>• Egg cell/Ovum and sperm</li> <li>•</li> </ul> <table border="1" data-bbox="269 642 1211 806"> <thead> <tr> <th>Egg cell</th> <th>Sperm</th> </tr> </thead> <tbody> <tr> <td>Large in size</td> <td>Small in size</td> </tr> <tr> <td>Non-motile</td> <td>Motile</td> </tr> <tr> <td>Spherical in shape</td> <td>Elongated</td> </tr> </tbody> </table> <p style="text-align: right;"><b>(any two)</b></p>	Egg cell	Sperm	Large in size	Small in size	Non-motile	Motile	Spherical in shape	Elongated	<p>½ , ½</p> <p>½ , ½</p>	2
Egg cell	Sperm										
Large in size	Small in size										
Non-motile	Motile										
Spherical in shape	Elongated										
24	<p>(a) Laws of Refraction of light :</p> <p>(i) The incident ray, the refracted ray and the normal to the interface of two transparent media at the point of incidence, all lie in the same plane.</p> <p>(ii) The ratio of the sine of angle of incidence to the sine of angle of refraction is a constant, for the light of a given colour and for the given pair of media.  <b>Note:</b>  If a student writes <math>\frac{\sin i}{\sin r} = \text{constant}</math> instead of statement, award ½ mark only)</p> <p style="text-align: center;"><b>OR</b></p> <p>(b) Absolute refractive index of a medium is the ratio of speed of light in vacuum to the speed of light in the medium.</p> <p>Given:  <math>c = 3 \times 10^8 \text{m/s}</math>; <math>n_m = 1.5</math>; <math>v_m = ?</math></p> <p>Absolute refractive index of a medium (<math>n_m</math>)</p> $= \frac{\text{speed of light in vacuum}}{\text{speed of light in medium}} = \frac{c}{v_m}$ $v_m = \frac{c}{n_m} = 2 \times 10^8 \text{m/s}$	<p>1</p> <p>1</p> <p>1</p> <p>½</p> <p>½</p>	2								





25	$R_s = R_1 + R_2 + R_3$ $= 1 + 2 + 3 = 6 \Omega$ $I = \frac{V}{R}$ $= \frac{2V}{6\Omega} = \frac{1}{3} A$ $V = IR$ $= \frac{1}{3} A \times 3(\Omega) = 1 V$	$\frac{1}{2}$  $\frac{1}{2}$  $\frac{1}{2}$	2
26	<ul style="list-style-type: none"> <li>• Non-biodegradable substances</li> <li>• <b>Two ways:</b> <ol style="list-style-type: none"> <li>(i) They are inert and persist in the environment for long time and cause pollution.</li> <li>(ii) Cause Biological magnification</li> <li>(iii) Affect the fertility of soil</li> </ol> </li> </ul> <p style="text-align: right;">(any two) (or any other)</p>	1  $\frac{1}{2}, \frac{1}{2}$	2
<b>SECTION C</b>			
27	<p>(a)</p> <p>(i) To facilitate efficient exchange of gases.</p> <p>(ii) It has high affinity for oxygen.</p> <p>(iii) Lack of oxygen does not oxidise glucose completely and forms a 3-Carbon molecule or lactic acid.</p> <p style="text-align: center;"><b>OR</b></p> <p>(b)</p> <p>(i) • Peristaltic movements • Muscles contract rhythmically in order to push the food forward in a regulated manner to be digested properly.</p> <p>(ii) • Gall bladder • Two roles: ➤ Emulsification of fats ➤ Makes the acidic medium alkaline.</p>	1  1  1  $\frac{1}{2}$ 1  $\frac{1}{2}$ $\frac{1}{2}$ $\frac{1}{2}$	3
28	<p>(a)</p> <ul style="list-style-type: none"> <li>• Pollen grains will not be transferred to the stigma and Hence fertilisation will not take place.</li> <li>• Ovule</li> <li>• Zygote develops into an embryo.</li> </ul>	1  $\frac{1}{2}$ $\frac{1}{2}$	

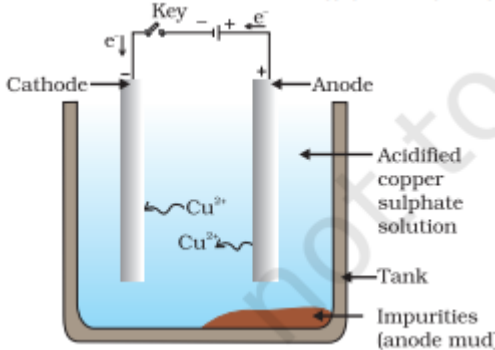

	(b) Testis – Anther Ovary – Ovary	$\frac{1}{2}$ $\frac{1}{2}$	3
29	(a) Observations: <ul style="list-style-type: none"> <li>• Formation of bubbles at both the electrodes.</li> <li>• These bubbles displace water in both the test tubes.</li> <li>• Volume of gas collected at Cathode is twice the volume of gas collected at anode.</li> </ul> <p style="text-align: right;">(Any two)</p> <p>(b) Cathode : Anode: H<sub>2</sub> : O<sub>2</sub> 1 : 8</p>	1,1  1	3
30	 <p style="text-align: center;">Diagram- Refer Figure 3·12 page 52 NCERT</p> <p style="text-align: center;">2 Labellings : Electrodes and Electrolyte.</p> <ul style="list-style-type: none"> <li>• When a current is passed through aqueous solution of CuSO<sub>4</sub>, the pure metal from the anode dissolves in the electrolyte (CuSO<sub>4</sub> solution) and equivalent amount of pure copper from CuSO<sub>4</sub> solution is deposited on the cathode.</li> </ul> <p><b>Alternate answer:</b>  At anode: <math>\text{Cu} \rightarrow \text{Cu}^{2+} + 2\text{e}^-</math>  At Cathode: <math>\text{Cu}^{2+} + 2\text{e}^- \rightarrow \text{Cu}</math></p>	1  1	3
31	(a) Here $f = -12$ cm, $u = -8$ cm, $v = ?$	$\frac{1}{2}$  $\frac{1}{2}$	
	Mirror formula $\frac{1}{v} + \frac{1}{u} = \frac{1}{f}$		



$$\therefore \frac{1}{v} = \frac{1}{f} - \frac{1}{u} = \frac{1}{-12 \text{ cm}} - \frac{1}{-8 \text{ cm}}$$

$$= + \frac{1}{24 \text{ cm}}$$

$$v = + 24 \text{ cm}$$

Image is formed at 24 cm behind the mirror.

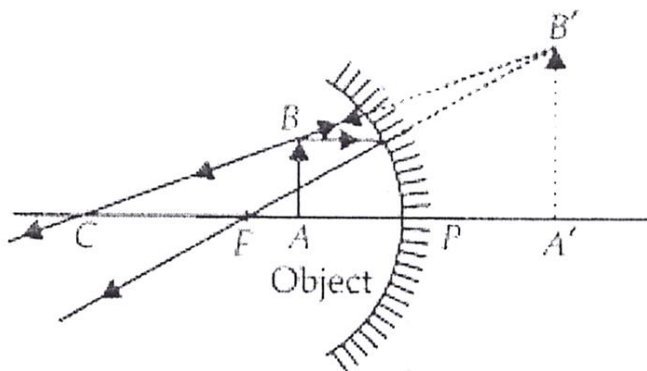

**Note:** Deduct ½ mark if direction of rays is not shown.

**OR**

(b)(i) Object is placed at 30 cm from the mirror.

**Note:** Award marks if expressed in the form of calculations.

**Reason:** Since magnification is -1, Image distance(v)= object distance(u)

(ii) Image is formed at infinity.

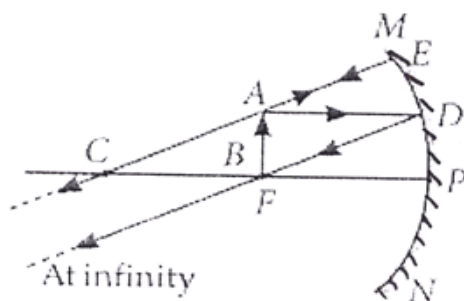

**Note:** Deduct ½ mark if direction of rays is not shown

1

1

½

½

1

1

3

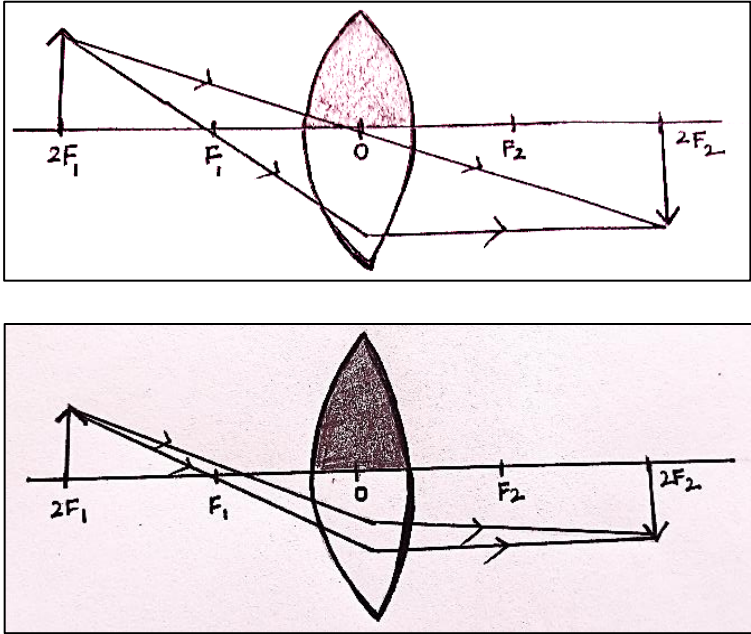
32	<p>(a)</p> <ul style="list-style-type: none"> <li>Stretch the thumb, forefinger and middle finger of your left hand such that they are mutually perpendicular. If the first finger points in the direction of magnetic field and the second finger in the direction of current, then the thumb will point in the direction of motion or the force acting on the conductor.</li> <li>Direction of force vertically downwards/Into the page</li> </ul> <p>(b) Electron will experience force in vertically upward direction/ will deflect out of the page.</p> <ul style="list-style-type: none"> <li><b>Reason:</b> Direction of flow of electrons is opposite to the direction of current in AB.</li> </ul>	1  ½  ½  1	3
33	<p>Phenomenon – Biological Magnification /Biomagnification</p> <ul style="list-style-type: none"> <li>Pesticides are washed down into the soil and water bodies.</li> <li>From the soil pesticides are absorbed by crop plants along with water and minerals and enter the food chain.</li> <li>These chemicals are non-biodegradable and get accumulated progressively at each trophic level.</li> <li>As human beings occupy the top level in any food chain, the maximum concentration of these chemicals gets accumulated in our bodies.</li> </ul>	1  ½  ½  ½  ½	3
<b>SECTION D</b>			
34	<p>(a)</p>  <p><b>Note: Any one of the above drawn ray diagrams should be marked.</b></p>	1	

	<p>When the upper half of lens is covered:</p> <ul style="list-style-type: none"> <li>• Position of image: at 2F on the other side of the lens</li> <li>• Nature of image: Real and inverted</li> <li>• <b>Observable difference in the image, if the lens is uncovered</b> The brightness of the image will increase</li> <li>• <b>Reason:</b> More number of rays will pass through the lens to form the image.</li> </ul> <p>(b) Here <math>u = -30</math> cm, <math>f = -15</math> cm, <math>v = ?</math></p> $\frac{1}{v} - \frac{1}{u} = \frac{1}{f}$ $\frac{1}{v} = \frac{1}{f} + \frac{1}{u}$ $= \frac{1}{-15} + \frac{1}{-30}$ $v = -10 \text{ cm}$	<p>1/2</p> <p>1/2</p> <p>1/2</p> <p>1/2</p> <p>1/2</p> <p>1</p>	<p>5</p>
35	<p>(a)</p> <p>(i)</p> <ul style="list-style-type: none"> <li>• Carbon cannot form <math>C^{4+}</math> cations because removal of 4 electrons from a carbon atom would require a large amount of energy and it cannot form <math>C^{4-}</math> anion because it would be difficult for the nucleus with 6 protons to hold 10 electrons.</li> <li>• Thus it shares electrons to form covalent compounds.</li> </ul> <p>(ii)</p> <ul style="list-style-type: none"> <li>• A series of compounds in which the same functional group substitutes for hydrogen in a carbon chain / series of compounds having same functional group and similar chemical properties.</li> <li>• <math>CH_3CHO</math>, <math>C_2H_5CHO</math> (any other consecutive members)</li> </ul> <p>(iii) Structure of cyclohexane (<math>C_6H_{12}</math>)</p>	<p>1</p> <p>1</p> <p>1</p> <p>1/2, 1/2</p>	



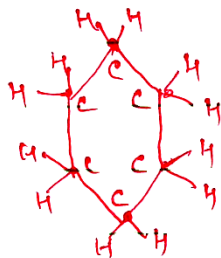

**OR**

**(b)**

(i) Ethanol – C<sub>2</sub>H<sub>5</sub>OH

(ii)

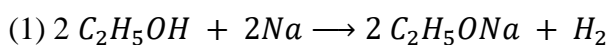

**Sodium Ethoxide**

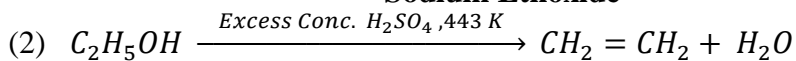

**Ethene**

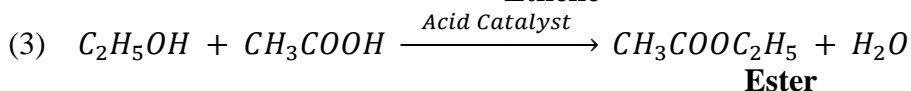

**Ester**

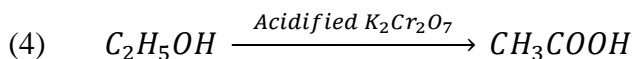

**Ethanoic acid**

**NOTE: Name of the product for each reaction is given in bold letters under the reaction.**

1

½, ½

½, ½

½, ½

½, ½

½, ½

5

36

(a) (i)

<b>Hormonal coordination in Plants</b>	<b>Hormonal coordination in Animals</b>
1) By simple diffusion	Transported through blood to the target organ
2) No specialised glands involved.	Hormone released by Endocrine glands.

- (ii) (1) Cerebrum/forebrain,  
 (2) cerebellum/hindbrain  
 (3) medulla/ hindbrain  
 (4) hypothalamus/forebrain.

- (iii) Brain – Bony box/skull/cranium/fluid filled balloon in skull,  
 Spinal cord – Backbone/Vertebral column.

**OR**

1,1

½ x 4

½

½



	<p>(b) (i) Plant growth movements in response to stimuli in a particular direction / directional movements due to light, gravity etc.</p> <p>(1) Plant growth inhibitor: Abscisic Acid</p> <p>(2) Promotes cell division – Cytokinins</p> <p>(ii) When the tendrils come in contact with any support, auxins move away from the point of contact of the support. More growth occurs on the side away from the support. As a result, unequal growth occurs on its two sides and thus tendrils coil/ circle around the support.</p> <ul style="list-style-type: none"> <li>• Auxins</li> </ul>	<p>1</p> <p>½</p> <p>½</p> <p>2</p> <p>1</p>	<p>5</p>
<b>SECTION E</b>			
37	<p>(a)</p> <ul style="list-style-type: none"> <li>• Higher resistivity than pure metals</li> <li>• Do not oxidise (burn) at high temperature.</li> </ul> <p>(b)</p> <ul style="list-style-type: none"> <li>• Higher resistivity than pure metals</li> <li>• Low melting point.</li> </ul> <p>(c)</p> <ul style="list-style-type: none"> <li>• Heating effect of electric current</li> <li>• When high current flows in the circuit accidentally, the fuse wire melts and breaks the circuit .</li> </ul> <p style="text-align: center;"><b>OR</b></p> <p>(c) <math>P = 1100 \text{ W}; V = 220 \text{ V}, I = ?</math></p> <p><math>P = VI</math></p> $I = \frac{P}{V} = \frac{1100 \text{ W}}{220 \text{ V}} = 5 \text{ A}$ <ul style="list-style-type: none"> <li>• No effect on the fuse of 5A rating.</li> </ul>	<p>½ , ½</p> <p>½ , ½</p> <p>1</p> <p>1</p> <p>½</p> <p>½</p> <p>1</p>	<p>4</p>
38	<p>(a) Acid – HCl, Base – NaOH</p> <p>(b) Cation <math>\text{Ca}^{2+}</math> Anion <math>\text{SO}_4^{2-}</math>,</p>	<p>½, ½</p> <p>½, ½</p>	

	(c) Salts having same cations but different anions belong to the same family of salts. e.g. sodium chloride (NaCl) and Washing Soda/sodium carbonate (Na <sub>2</sub> CO <sub>3</sub> ) both have Na <sup>+</sup> as cation. <b>OR</b> c) • A scale for measuring hydrogen ion (H <sup>+</sup> ) concentration in a solution is called pH scale. • Potassium Sulphate / K <sub>2</sub> SO <sub>4</sub> • pH = 7	2  1 ½ ½						
39	(a) All cut pieces of the two planaria will form a complete organism.  (b) Hydra  (c) Specialised cells proliferate to make a large number of cells. This mass of cells change to make different cell types and tissues. These changes take place in an organised sequence and is called development.  <b>OR</b> (c)	1  1  2						
	<table border="1"> <tr> <td>Regeneration</td> <td>Fragmentation</td> </tr> <tr> <td>Specialised cells proliferate to form new cells which multiply and form a a new individual</td> <td>Each piece/fragment grows by cell-to-cell division to form a new organism.</td> </tr> </table>	Regeneration	Fragmentation	Specialised cells proliferate to form new cells which multiply and form a a new individual	Each piece/fragment grows by cell-to-cell division to form a new organism.	1,1		4
Regeneration	Fragmentation							
Specialised cells proliferate to form new cells which multiply and form a a new individual	Each piece/fragment grows by cell-to-cell division to form a new organism.							

\*\*\*\*\*



**Marking Scheme**  
**Strictly Confidential**  
**(For Internal and Restricted use only)**  
**Secondary School Examination, 2024**  
**SUBJECT NAME SCIENCE (086) (Q.P. CODE 31/2/3)**

General Instructions: -

1	You are aware that evaluation is the most important process in the actual and correct assessment of the candidates. A small mistake in evaluation may lead to serious problems which may affect the future of the candidates, education system and teaching profession. To avoid mistakes, it is requested that before starting evaluation, you must read and understand the spot evaluation guidelines carefully.
2	“Evaluation policy is a confidential policy as it is related to the confidentiality of the examinations conducted, Evaluation done and several other aspects. Its’ leakage to public in any manner could lead to derailment of the examination system and affect the life and future of millions of candidates. Sharing this policy/document to anyone, publishing in any magazine and printing in News Paper/Website etc may invite action under various rules of the Board and IPC.”
3	Evaluation is to be done as per instructions provided in the Marking Scheme. It should not be done according to one’s own interpretation or any other consideration. Marking Scheme should be strictly adhered to and religiously followed. However, while evaluating, answers which are based on latest information or knowledge and/or are innovative, they may be assessed for their correctness otherwise and due marks be awarded to them. In class-X, while evaluating two competency-based questions, please try to understand given answer and even if reply is not from marking scheme but correct competency is enumerated by the candidate, due marks should be awarded.
4	The Marking scheme carries only suggested value points for the answers These are in the nature of Guidelines only and do not constitute the complete answer. The students can have their own expression and if the expression is correct, the due marks should be awarded accordingly.
5	The Head-Examiner must go through the first five answer books evaluated by each evaluator on the first day, to ensure that evaluation has been carried out as per the instructions given in the Marking Scheme. If there is any variation, the same should be zero after deliberation and discussion. The remaining answer books meant for evaluation shall be given only after ensuring that there is no significant variation in the marking of individual evaluators.
6	Evaluators will mark(√) wherever answer is correct. For wrong answer CROSS ‘X’ be marked. Evaluators will not put right (√)while evaluating which gives an impression that answer is correct and no marks are awarded. This is most common mistake which evaluators are committing.
7	If a question has parts, please award marks on the right-hand side for each part. Marks awarded for different parts of the question should then be totaled up and written in the left-hand margin and encircled. This may be followed strictly.
8	If a question does not have any parts, marks must be awarded in the left-hand margin and encircled. This may also be followed strictly.
9	If a student has attempted an extra question, answer of the question deserving more marks should be retained and the other answer scored out with a note “Extra Question”.



10	No marks to be deducted for the cumulative effect of an error. It should be penalized only once.
11	A full scale of marks 0 – 80 (example 0 to 80/70/60/50/40/30 marks as given in Question Paper) has to be used. Please do not hesitate to award full marks if the answer deserves it.
12	Every examiner has to necessarily do evaluation work for full working hours i.e., 8 hours every day and evaluate 20 answer books per day in main subjects and 25 answer books per day in other subjects (Details are given in Spot Guidelines). This is in view of the reduced syllabus and number of questions in question paper.
13	Ensure that you do not make the following common types of errors committed by the Examiner in the past:- Leaving answer or part thereof unassessed in an answer book. Giving more marks for an answer than assigned to it. Wrong totaling of marks awarded on an answer. Wrong transfer of marks from the inside pages of the answer book to the title page. Wrong question wise totaling on the title page. Wrong totaling of marks of the two columns on the title page. Wrong grand total. Marks in words and figures not tallying/not same. Wrong transfer of marks from the answer book to online award list. Answers marked as correct, but marks not awarded. (Ensure that the right tick mark is correctly and clearly indicated. It should merely be a line. Same is with the X for incorrect answer.) Half or a part of answer marked correct and the rest as wrong, but no marks awarded.
14	While evaluating the answer books if the answer is found to be totally incorrect, it should be marked as cross (X) and awarded zero (0) Marks.
15	Any unassessed portion, non-carrying over of marks to the title page, or totaling error detected by the candidate shall damage the prestige of all the personnel engaged in the evaluation work as also of the Board. Hence, in order to uphold the prestige of all concerned, it is again reiterated that the instructions be followed meticulously and judiciously.
16	The Examiners should acquaint themselves with the guidelines given in the “Guidelines for Spot Evaluation” before starting the actual evaluation.
17	Every Examiner shall also ensure that all the answers are evaluated, marks carried over to the title page, correctly totaled and written in figures and words.
18	The candidates are entitled to obtain photocopy of the Answer Book on request on payment of the prescribed processing fee. All Examiners/Additional Head Examiners/Head Examiners are once again reminded that they must ensure that evaluation is carried out strictly as per value points for each answer as given in the Marking Scheme.



**MARKING SCHEME**  
**Secondary School Examination, 2024**  
**SCIENCE (Subject Code–086)**  
**[ Paper Code: 31/2/3]**

**Maximum Marks: 80**

Q. No.	EXPECTED ANSWER / VALUE POINTS	Marks	Total Marks
<b>SECTION A</b>			
1	(B)/ brown deposit	1	1
2	(D) /(b) and (d)	1	1
3	(D) /Decomposition of calcium carbonate to form quick lime and carbon dioxide	1	1
4	(B)/ Al <sub>2</sub> O <sub>3</sub>	1	1
5	(C) /Tartaric acid	1	1
6	(A) /(a) and (b)	1	1
7	(C) /SO <sub>2</sub> is an oxidising agent and H <sub>2</sub> S is a reducing agent	1	1
8	(D) /Bryophyllum	1	1
9	(A) /Pituitary	1	1
10	(B)/ Lifted ribs and flattened diaphragm	1	1
11	(C) /(b) and (c)	1	1
12	(C) /Tt and tt	1	1
13	(C) /R <sub>3</sub> > R <sub>2</sub> > R <sub>1</sub>	1	1
14	(A) /1 Ω	1	1
15	(C) / 4/3	1	1
16	(C) /(a) and (c)	1	1
17	(D) / (A) is false, but (R) is true.	1	1
18	(D)/ (A) is false, but (R) is true.	1	1
19	(C) / (A) is true, but (R) is false	1	1
20	(B)/ Both (A) and (R) are true but Reason (R) is <i>not</i> the correct explanation of Assertion (A).	1	1
<b>SECTION B</b>			
21	(a) (i) Chemical equations showing evolution of gas : $\text{Zn(s)} + \text{H}_2\text{SO}_4(\text{aq}) \longrightarrow \text{ZnSO}_4(\text{aq}) + \text{H}_2(\text{g})$ (or any other reaction)	1	
	(ii) Change in colour of substance during a chemical reaction $2\text{Cu (s)} + \text{O}_2 (\text{s}) \xrightarrow{\text{Heat}} 2 \text{CuO (s)}$ (reddish-brown) (black) (or any other reaction)	1	

	<b>OR</b>		
	(b) (i) $2 H_2S (g) + 3 O_2(g) \longrightarrow 2 SO_2 (g) + 2 H_2O (l)$ (ii) $2 AgBr(s) \xrightarrow{\text{sunlight}} 2 Ag (s) + Br_2(g)$ <i>Note: If the equations are not balanced, deduct half mark for each reaction.</i>	1 1	2
22	<ul style="list-style-type: none"> <li>Renal Artery</li> <li>Nephron filters the blood in the kidney / removes nitrogenous wastes/urea/uric acid from it.</li> <li>Selective reabsorption of certain substances present in the initial filtrate like glucose, amino acids, salt and water.</li> </ul>	½ ½ 1	2
23	<ul style="list-style-type: none"> <li>F<sub>1</sub> generation : Round and Yellow seeds</li> <li>F<sub>2</sub> generation : Four combinations Round and Yellow – 9 Round and Green – 3 Wrinkled and Yellow – 3 Wrinkled and Green – 1,</li> </ul> <p style="text-align: center;"><b>NOTE: 1 mark for combinations, <math>\frac{1}{2}</math> mark for ratio.</b></p>	½  1 ½	2
24	$R_s = R_1 + R_2 + R_3$ $= 1 + 2 + 3 = 6 \Omega$  $I = \frac{V}{R}$ $= \frac{2V}{6\Omega} = \frac{1}{3} A$  $V = IR$ $= \frac{1}{3} A \times 3(\Omega) = 1 V$	½  ½ ½  ½	2
25	(a) <ul style="list-style-type: none"> <li>Myopia</li> <li>Two causes :</li> </ul>	½	

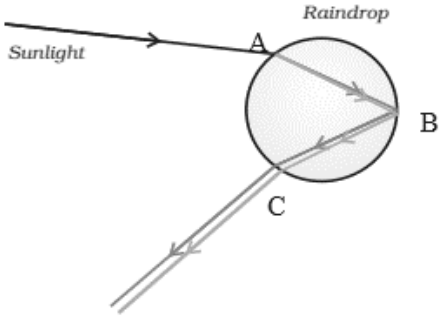

	<p>Excessive curvature of eye lens Elongation of eye ball</p> <ul style="list-style-type: none"> <li>• Diverging lens</li> </ul> <p style="text-align: center;"><b>OR</b></p> <p>(b)</p> <ul style="list-style-type: none"> <li>• The power of accommodation of eye lens usually decreases with ageing and the person finds it difficult to see nearby objects comfortably and distinctly.</li> <li>• Convex lens (Bifocal lens if the person has myopia also.)</li> <li>• The upper part of bifocal lens will be diverging.</li> </ul>	<p>½ ½ ½</p> <p>1 ½ ½</p>	2
26	<ul style="list-style-type: none"> <li>• Non-biodegradable substances</li> <li>• <b>Two ways:</b> <ol style="list-style-type: none"> <li>(i) They are inert and persist in the environment for long time and cause pollution.</li> <li>(ii) Cause Biological magnification</li> <li>(iii) Affect the fertility of soil</li> </ol> </li> </ul> <p style="text-align: center;"><b>(any two) (or any other)</b></p>	<p>1 ½ ½</p>	2
<b>SECTION C</b>			
27	<p>(a) Sodium metal reacts vigorously and catches fire if kept in open.</p> <p>(b) Alkalis. e.g. NaOH/KOH</p> <p>(c) Composition of this layer is the respective metal oxide. It prevents the metal from further oxidation/ protects the metal.</p>	<p>1 ½, ½ ½, ½</p>	3
28	<ul style="list-style-type: none"> <li>• Bubbles of hydrogen gas formed stick to the surface of calcium and make it lighter than water.</li> </ul> $Ca(s) + 2H_2O(l) \longrightarrow Ca(OH)_2(aq) + H_2(g)$ <ul style="list-style-type: none"> <li>• The solution formed turns milky.</li> </ul> $Ca(OH)_2(aq) + CO_2(g) \longrightarrow CaCO_3(s) + H_2O(l)$	<p>½ 1 ½ 1</p>	3
29	<p>(a)</p> <ul style="list-style-type: none"> <li>• Oral pills/chemical method : Change hormonal balance so eggs are not released.</li> <li>• Loop/Copper T : Prevents pregnancy by checking the entry of sperms through the vagina.</li> <li>• Surgical method: It does not allow egg to reach the uterus.</li> </ul> <p style="text-align: right;"><b>(any two)</b></p>	<p>½, ½ ½, ½</p>	

	<p><b>(b) Two roles of testes :</b></p> <p>(i) Formation of sperms</p> <p>(ii) Secretion of hormone testosterone</p>	<p><math>\frac{1}{2}</math></p> <p><math>\frac{1}{2}</math></p>	<p>3</p>
30	<p>(a)</p> <p>(i) To facilitate efficient exchange of gases.</p> <p>(ii) It has high affinity for oxygen.</p> <p>(iii) Lack of oxygen does not oxidise glucose completely and forms a 3-Carbon molecule or lactic acid.</p> <p style="text-align: center;"><b>OR</b></p> <p>(b)</p> <p>(i) • Peristaltic movements</p> <p>• Muscles contract rhythmically in order to push the food forward in a regulated manner to be digested properly.</p> <p>(ii) • Gall bladder</p> <p>• Two roles:</p> <p>➤ Emulsification of fats</p> <p>➤ Makes the acidic medium alkaline.</p>	<p>1</p> <p>1</p> <p>1</p> <p><math>\frac{1}{2}</math></p> <p>1</p> <p><math>\frac{1}{2}</math></p> <p><math>\frac{1}{2}</math></p> <p><math>\frac{1}{2}</math></p>	<p>3</p>
31	<p>(a)</p> <p>• Ability of the eye lens to adjust its focal length.</p> <p>• Ciliary muscles</p> <p>• (i) While focusing on nearby objects ciliary muscles contract, eye lens becomes thick and its focal length decreases.</p> <p>(ii) While focusing on distant objects ciliary muscles relax, eye lens becomes thin and its focal length increases.</p> <p style="text-align: center;"><b>OR</b></p> <p>(b)</p> 	<p>1</p> <p>1</p> <p><math>\frac{1}{2}</math></p> <p><math>\frac{1}{2}</math></p> <p><math>\frac{1}{2}</math></p>	

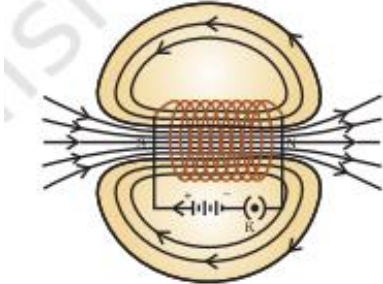

	<p>Diagram Reference figure 10.8 page 167 NCERT</p> <p style="text-align: right;"><b>3 Labellings (A, B, C)</b></p> <ul style="list-style-type: none"> <li>Two conditions : <ul style="list-style-type: none"> <li>(i) Presence of tiny water droplets in the atmosphere.</li> <li>(ii) Position of Sun at the back of/behind the observer.</li> </ul> </li> </ul>	<p><math>\frac{1}{2} \times 3</math></p> <p><math>\frac{1}{2}</math></p> <p><math>\frac{1}{2}</math></p>	3				
32	<ul style="list-style-type: none"> <li>Solenoid : A coil of many circular turns of insulated copper wire wrapped closely in the shape of a cylinder.</li> </ul>  <p style="text-align: center;">Refer figure 12.10 page 201 NCERT (Note: Deduct <math>\frac{1}{2}</math> mark if direction of magnetic field lines not shown)</p> <ul style="list-style-type: none"> <li>A strong magnetic field produced inside a solenoid can be used to magnetise a piece of soft iron kept inside it.</li> </ul>	<p>1</p> <p>1</p> <p>1</p>	3				
33	<p>Phenomenon – Biological Magnification /Biomagnification</p> <ul style="list-style-type: none"> <li>Pesticides are washed down into the soil and water bodies.</li> <li>From the soil pesticides are absorbed by crop plants along with water and minerals and enter the food chain.</li> <li>These chemicals are non-biodegradable and get accumulated progressively at each trophic level.</li> <li>As human beings occupy the top level in any food chain, the maximum concentration of these chemicals gets accumulated in our bodies.</li> </ul>	<p>1</p> <p><math>\frac{1}{2}</math></p> <p><math>\frac{1}{2}</math></p> <p><math>\frac{1}{2}</math></p> <p><math>\frac{1}{2}</math></p>	3				
<b>SECTION D</b>							
34	<p>(a)</p> <p>(i)</p> <table border="1" style="width: 100%;"> <tr> <td style="width: 50%;">Hormonal coordination in Plants</td> <td style="width: 50%;">Hormonal coordination in Animals</td> </tr> <tr> <td>1) By simple diffusion</td> <td>Transported through blood to the target organ</td> </tr> </table>	Hormonal coordination in Plants	Hormonal coordination in Animals	1) By simple diffusion	Transported through blood to the target organ	<p>1,1</p>	
Hormonal coordination in Plants	Hormonal coordination in Animals						
1) By simple diffusion	Transported through blood to the target organ						

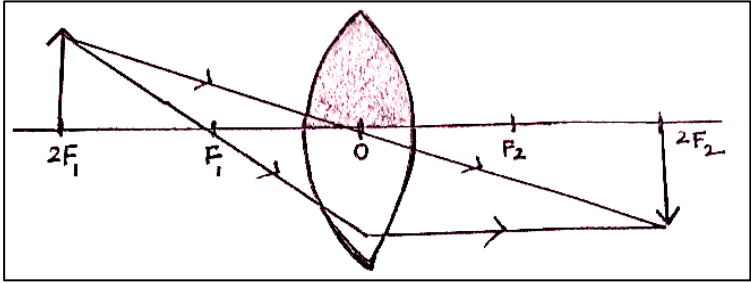
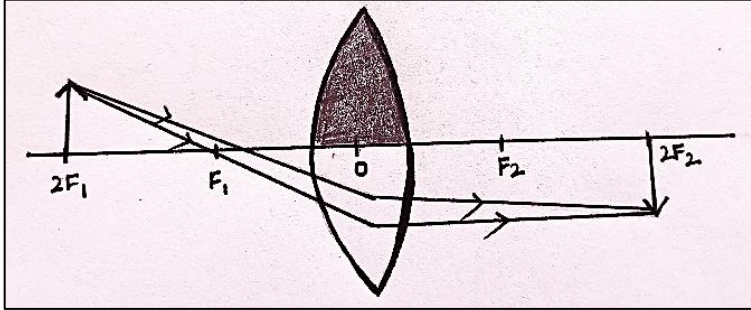
	<p>2) No specialised glands involved.</p> <p>(ii) (1) Cerebrum/forebrain, (2) cerebellum/hindbrain (3) medulla/ hindbrain (4) hypothalamus/forebrain.</p> <p>(iii) Brain – Bony box/skull/cranium/fluid filled balloon in skull, Spinal cord – Backbone/Vertebral column.</p> <p style="text-align: center;"><b>OR</b></p> <p>(b) (i) Plant growth movements in response to stimuli in a particular direction / directional movements due to light, gravity etc.</p> <p>(1) Plant growth inhibitor: Abscisic Acid (2) Promotes cell division – Cytokinins</p> <p>(ii) When the tendrils come in contact with any support, auxins move away from the point of contact of the support. More growth occurs on the side away from the support. As a result, unequal growth occurs on its two sides and thus tendrils coil/ circle around the support.</p> <p>• <i>Auxins</i></p>	<p>Hormone released by Endocrine glands.</p>	<p><math>\frac{1}{2} \times 4</math></p> <p><math>\frac{1}{2}</math> <math>\frac{1}{2}</math></p> <p>1</p> <p><math>\frac{1}{2}</math> <math>\frac{1}{2}</math></p> <p>2</p> <p>1</p>	<p>5</p>
<p>35</p>	<p>(a)</p> <div style="display: flex; flex-direction: column; align-items: center;">   </div>	<p>1</p>		



	<p><b>Note: Any one of the above drawn ray diagrams should be marked.</b></p> <p>When the upper half of lens is covered:</p> <ul style="list-style-type: none"> <li>• Position of image: at 2F on the other side of the lens</li> <li>• Nature of image: Real and inverted</li> <li>• <b>Observable difference in the image, if the lens is uncovered</b> The brightness of the image will increase</li> <li>• <b>Reason:</b> More number of rays will pass through the lens to form the image.</li> </ul> <p>(b) Here <math>u = -30</math> cm, <math>f = -15</math> cm, <math>v = ?</math></p> $\frac{1}{v} - \frac{1}{u} = \frac{1}{f}$ $\frac{1}{v} = \frac{1}{f} + \frac{1}{u}$ $= \frac{1}{-15} + \frac{1}{-30}$ $v = -10 \text{ cm}$	<p><math>\frac{1}{2}</math></p> <p><math>\frac{1}{2}</math></p> <p><math>\frac{1}{2}</math></p> <p><math>\frac{1}{2}</math></p> <p><math>\frac{1}{2}</math></p> <p><math>\frac{1}{2}</math></p> <p>1</p>	<p>5</p>
36	<p>(a)</p> <p>(i)</p> <ul style="list-style-type: none"> <li>• Carbon cannot form <math>C^{4+}</math> cations because removal of 4 electrons from a carbon atom would require a large amount of energy and it cannot form <math>C^{4-}</math> anion because it would be difficult for the nucleus with 6 protons to hold 10 electrons.</li> <li>• Thus it shares electrons to form covalent compounds.</li> </ul> <p>(ii)</p> <ul style="list-style-type: none"> <li>• A series of compounds in which the same functional group substitutes for hydrogen in a carbon chain / series of compounds having same functional group and similar chemical properties.</li> <li>• <math>CH_3CHO</math>, <math>C_2H_5CHO</math> (any other consecutive members)</li> </ul> <p>(iii) Structure of cyclohexane (<math>C_6H_{12}</math>)</p>	<p>1</p> <p>1</p> <p>1</p> <p><math>\frac{1}{2}, \frac{1}{2}</math></p>	



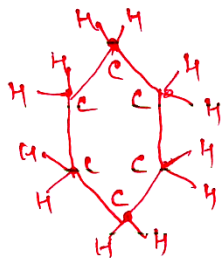

OR

(b)

(i) Ethanol – C<sub>2</sub>H<sub>5</sub>OH

(ii)

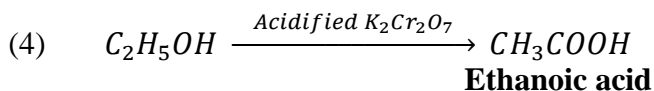
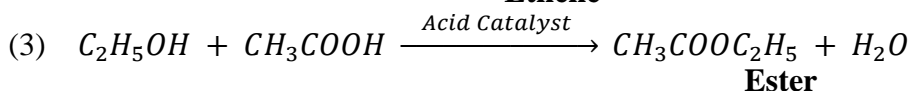
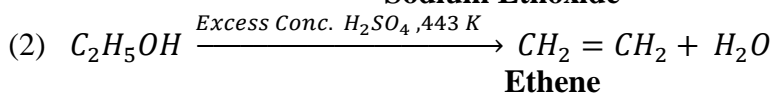
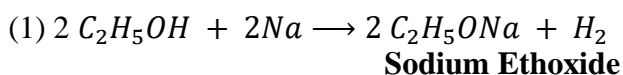

**NOTE: Name of the product for each reaction is given in bold letters under the reaction.**

**SECTION E**

37 (a) All cut pieces of the two planaria will form a complete organism.

(b) Hydra

(c) Specialised cells proliferate to make a large number of cells. This mass of cells change to make different cell types and tissues. These changes take place in an organised sequence and is called development.

OR

(c)

Regeneration	Fragmentation
Specialised cells proliferate to form new cells which multiply and form a a new individual	Each piece/fragment grows by cell-to-cell division to form a new organism.

38 (a)

	<ul style="list-style-type: none"> <li>Higher resistivity than pure metals</li> <li>Do not oxidise (burn) at high temperature.</li> </ul> <p>(c)</p> <ul style="list-style-type: none"> <li>Higher resistivity than pure metals</li> <li>Low melting point.</li> </ul> <p>(c)</p> <ul style="list-style-type: none"> <li>Heating effect of electric current</li> </ul> <ul style="list-style-type: none"> <li>When high current flows in the circuit accidentally, the fuse wire melts and breaks the circuit .</li> </ul> <p style="text-align: center;"><b>OR</b></p> <p>(c) <b>P = 1100 W; V = 220 V, I = ?</b></p> <p><math>P = VI</math></p> $I = \frac{P}{V} = \frac{1100 \text{ W}}{220 \text{ V}} = 5 \text{ A}$ <ul style="list-style-type: none"> <li>No effect on the fuse of 5A rating.</li> </ul>	<p>1/2 , 1/2</p> <p>1/2 , 1/2</p> <p>1</p> <p>1</p> <p>1/2</p> <p>1/2</p> <p>1</p>	<p>4</p>
39	<p>(a) Acid – HCl, Base – NaOH</p> <p>(b) Cation <math>\text{Ca}^{2+}</math> Anion <math>\text{SO}_4^{2-}</math>,</p> <p>(c) Salts having same cations but different anions belong to the same family of salts. e.g. sodium chloride (NaCl) and Washing Soda/sodium carbonate (<math>\text{Na}_2\text{CO}_3</math>) both have <math>\text{Na}^+</math> as cation.</p> <p style="text-align: center;"><b>OR</b></p> <p>c) • A scale for measuring hydrogen ion (<math>\text{H}^+</math>) concentration in a solution is called pH scale.</p> <ul style="list-style-type: none"> <li>Potassium Sulphate / <math>\text{K}_2\text{SO}_4</math> <ul style="list-style-type: none"> <li><math>\text{pH} = 7</math></li> </ul> </li> </ul>	<p>1/2, 1/2</p> <p>1/2, 1/2</p> <p>2</p> <p>1</p> <p>1/2</p> <p>1/2</p>	<p>4</p>

\*\*\*\*\*

